

TYPE: LX-WPU-

KEY FEATURES

- A suspended acoustic baffle combined with a high-performance upwards wash dimmable LED light source (Indirect)
- Mix and match with Waffle Pendant Downlit and Waffle Acoustic Discs
- Highly effective noise absorption
- Available in 4 sizes, 2 patterns and 50 premium wool colors
- Height adjustable 9' / 3m suspension cables and Black woven power cable
- IES photometric files available
- L70 lifetime rating of 50,000 hours

OPTIONAL EXTRAS

- Additional options available upon request
- 0.1% dimming option
 - POE
 - Bluetooth controller (US & EU only)
 - Tunable White output
 - White canopy and power cord

SIZE, OUTPUT AND PATTERN

DONUT

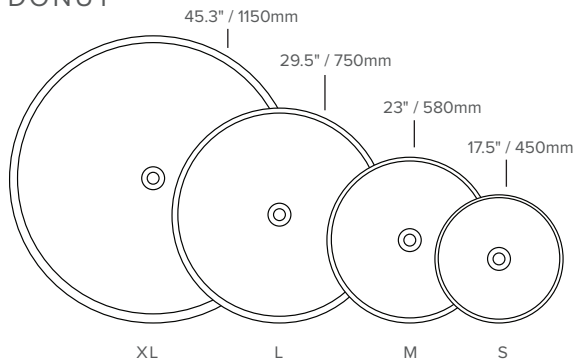

ORANGE

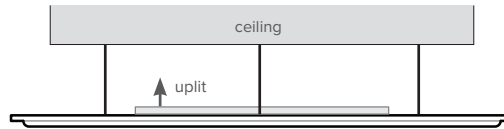
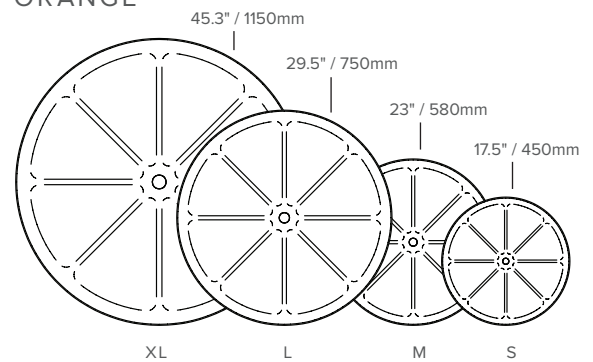

	SMALL	MEDIUM	LARGE	EXTRA LARGE
Delivered Lumen Output	1833lm	1833lm	5133 lm	5133 lm
Wattage	22W	22W	58.9 W	58.9 W
Efficacy	83 lm/W	83 lm/W	87.2 lm/W	87.2 lm/W

ORDER CODE

EXAMPLE: LX - WPU - L - 2R - D - I - 35 - UNV - RD

(Luxbox Waffle Disc, large (dia 29.5 / 750mm), color 2R, donut pattern, indirect light, 3500K color temperature, Universal 110-277VAC / 0-10V dimming, remote driver)

LX - WPU	SIZE	COLOR	PATTERN	COLOR TEMP	REGION / DIMMING	DRIVER TYPE
WPU	S	dia 17.5"/450mm	O Orange D Donut	30	UNV 0 - 10V - 1% dimming (120-277V) (North America only) G* 1% dimming DSI/DALI (220 - 240V)	CD Canopy concealed driver (UNV/North America only) RD Remote driver (UNV or G)
	M	dia 23"/580mm		35		
	L	dia 29.5"/750mm		40		
	XL	dia 45.3"/1150mm				

* Global (G) dimming type is available with Remote driver (RD) only

Luxbox reserves the right to change the specification, material and colors at any time without notice. Standard warranty terms and conditions apply. All rights reserved © All dimensions and values on specification sheet are nominal. February 2024. LX-Waffle-Pendant-Uplite-Spec-Sheet.V2



WAFFLE PENDANT UPLIT

TYPE: LX-WPU-

AVAILABLE COLORS

Colors are subject to lead times and variations across batches

4M	2T	4T	4C	3V	21	3W	3Q	4N	18
13	39	63	90	3P	3T	4Q	3N	4L	3L
4U	3S	82	4R	3M	58	2W	47	86	4X
4A	4D	2Q	1E	28	4W	1J	31	30	35
1R	1V	1W	1P	1Y	12	67	08	02	4H
3Z	2U	2Z	3X	3B	4B	4S	4K	33	4J
4P	09	26	62	1F	1K	1L	53	3U	1N
3Y	3R	3A	4V	4F	4E	4G			

Luxbox reserves the right to change the specification, material and colors at any time without notice. Standard warranty terms and conditions apply. All rights reserved © All dimensions and values on specification sheet are nominal. February 2024. LX-Waffle-Pendant-Uplight-Spec-Sheet.V2



LUXXBOX USA INC × (P)+1 (415) 871 0448 × USA@LUXXBOX.COM
LUXXBOX PTY LTD × (P)+61 7 3257 2822 × INFO@LUXXBOX.COM
WWW.LUXXBOX.COM





WAFFLE PENDANT UPLIT

TYPE: LX-WPU-

PHOTOMETRICS

LIGHT SOURCE SPECIFICATIONS

	SMALL	MEDIUM	LARGE	EXTRA LARGE
	Indirect	Indirect	Indirect	Indirect
Delivered Lumen Output	1634 lm	1634 lm	5133 lm	5133 lm
Wattage	24 W	24 W	58.9 W	58.9 W
Efficacy	68 lm/W	68 lm/W	87.2 lm/W	87.2 lm/W
CRI	90+			
CCT	3000, 3500, 4000 K			

LUMINOUS INTENSITY DISTRIBUTION (INDIRECT)

SMALL / MEDIUM

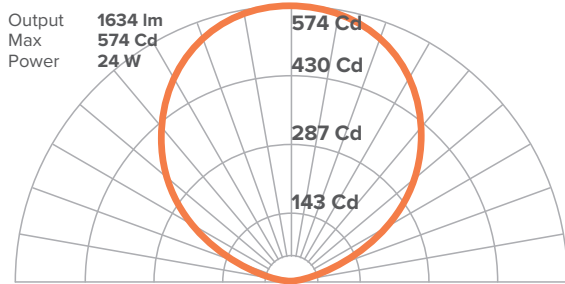

LARGE / EXTRA LARGE

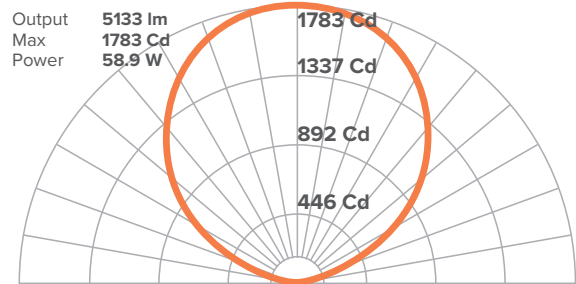

TM-30METRICS

Fidelity Index (Rf): Average similarity to the reference source for all colors
Gamut Index (Rg): Average change in chroma for all colors

	SMALL / MEDIUM	LARGE / EXTRA LARGE
Rf (Fidelity Index)	90	90.7
Rg (Gamut Index)	100	98.8

COLOR VECTOR GRAPHIC

SMALL / MEDIUM

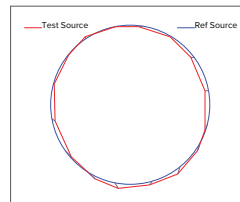

LARGE / EXTRA LARGE

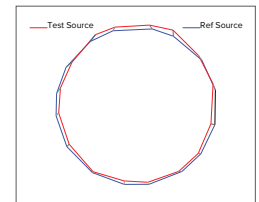

Luxbox reserves the right to change the specification, material and colors at any time without notice. Standard warranty terms and conditions apply. All rights reserved © All dimensions and values on specification sheet are nominal. February 2024. LX-Waffle-Pendant-Uplight-Spec-Sheet.V2



LUXXBOX USA INC × (P)+1 (415) 871 0448 × USA@LUXXBOX.COM
LUXXBOX PTY LTD × (P)+61 7 3257 2822 × INFO@LUXXBOX.COM
WWW.LUXXBOX.COM





WAFFLE PENDANT UPLIT

TYPE: LX-WPU-

MATERIAL SPECIFICATIONS

COLOR FASTNESS TO LIGHT:	ISO 105-B02-1994 Rating: 6-7
FIRE TEST:	AS 1530.3 ISO 9705: Group 1 GB8624 B1 BS EN 13501: Classification B-s1, d0
ENVIRONMENTAL:	PET achieves GreenTag Certification GreenRate: Level A
THERMAL TRANSITION:	ASTM C518-2010. R- Value = 0.30 m ² K/W
SOUND ABSORPTION:	AS ISO 354 – 2006 Noise reduction coefficient (NRC) = 0.7
VOC EMISSIONS:	ASTM D5116 Rate: < 0.02 mg/m ³ /hr (7 days)

PRODUCT ACOUSTIC PROPERTIES

Testing and post analysis procedures were carried out in accordance with the references detailed below:

AS ISO 354-2006 (R2016)	Acoustics—Measurement of sound absorption in a reverberation room
AS ISO 11654—2002	Rating of sound absorption—Materials and systems
ASTM C423-17	Standard Test Method for Sound Absorption and Sound Absorption Coefficients by the Reverberation Room Method
ASTM E795-16	Standard Practices for Mounting Test Specimens During Sound Absorption Tests
ISO 20189	Screens, furniture and single objects intended for interior use. Rating of sound absorption and sound reduction of elements based on laboratory measurements.

IMPERIAL SABINS	SMALL	MEDIUM	LARGE	EXTRA LARGE
Frequency (Hz)				
125	0.19	0.31	0.52	1.23
250	0.12	0.20	0.33	0.78
500	0.46	0.77	1.28	3.02
1000	0.80	1.34	2.23	5.25
2000	1.08	1.79	2.99	7.04
4000	1.42	2.36	3.94	9.28

METRIC SABINS	SMALL	MEDIUM	LARGE	EXTRA LARGE
Frequency (Hz)				
125	0.02	0.03	0.05	0.11
250	0.01	0.02	0.03	0.07
500	0.04	0.07	0.12	0.28
1000	0.07	0.12	0.21	0.49
2000	0.10	0.17	0.28	0.65
4000	0.13	0.22	0.37	0.86

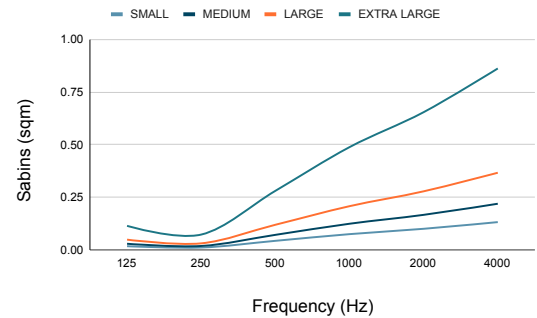
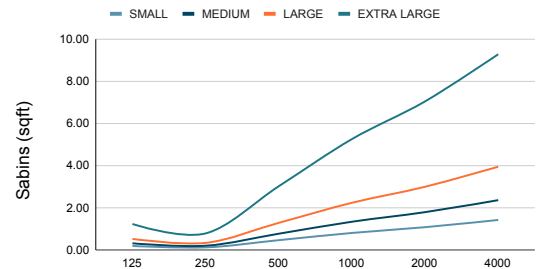

The Sabin data shown above is in accordance with the latest International Standards for the rating of sound absorption and reduction. This is different from the classic methodology, which includes the calculation of the Noise Reduction Coefficient (NRC), the Sound Absorption Average (SAA), the Weighted Sound Absorption Coefficient (**aw**) and the Sound Absorption Class (SAC). However, to make it easier to compare against other products, we are including that information on the table on the right, which was calculated using the Largest Single Face method. Fully detailed test reports are available upon request.

NRC	0.75
SAA	0.76
aw	0.65 (H))
SAC	C

Luxxbox reserves the right to change the specification, material and colors at any time without notice. Standard warranty terms and conditions apply. All rights reserved © All dimensions and values on specification sheet are nominal. February 2024. LX-Waffle-Pendant-Uplight-Spec-Sheet.V2



LUXXBOX USA INC × (P)+1 (415) 871 0448 × USA@LUXXBOX.COM
 LUXXBOX PTY LTD × (P)+61 7 3257 2822 × INFO@LUXXBOX.COM
 WWW.LUXXBOX.COM





WAFFLE PENDANT UPLIT

TYPE: LX-WPU-

DRIVER INFORMATION

REGION/DIMMING	SIZE	WATTAGE (W)	MAX VOLTAGE (V)	COMPLIANCE
UNIVERSAL (UNV) 0-10V - 1% dimming 110 - 277VAC <i>(North America only)</i>	SMALL / MEDIUM	22W	10-55VDC	
	LARGE / EXTRA LARGE	48W		
GLOBAL (G) 0-10V - 1% dimming 220 - 240VAC DSI DALI	SMALL / MEDIUM	22W	20-46VDC	
	LARGE / EXTRA LARGE	48W	20-40VDC	

CANOPY INFORMATION

Please note power cord and canopy will always be supplied in black unless specified otherwise.

SIZE	UNV (NORTH AMERICA)		G (GLOBAL)
	CD	RD	RD
WPU-S/M/L/XL	CD5	SA5	SB1

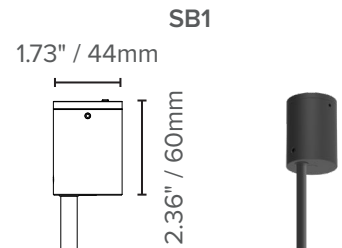
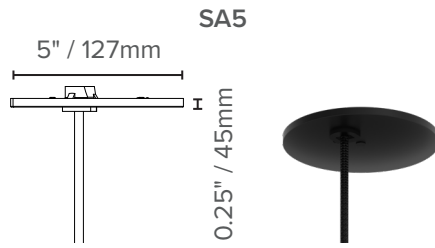
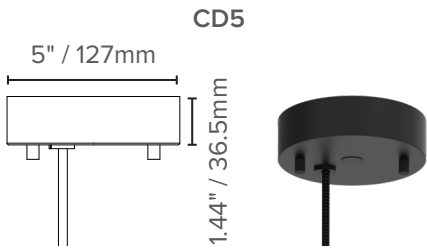

Luxxbox reserves the right to change the specification, material and colors at any time without notice. Standard warranty terms and conditions apply. All rights reserved © All dimensions and values on specification sheet are nominal. February 2024. LX-Waffle-Pendant-Uplight-Spec-Sheet.V2



LUXXBOX USA INC × (P)+1 (415) 871 0448 × USA@LUXXBOX.COM
 LUXXBOX PTY LTD × (P)+61 7 3257 2822 × INFO@LUXXBOX.COM
 WWW.LUXXBOX.COM





WAFFLE PENDANT UPLIT

TYPE: LX-WPU-

SUSPENSION POINTS

(All suspended Discs supplied with 9' / 3m of height adjustable suspension cables)

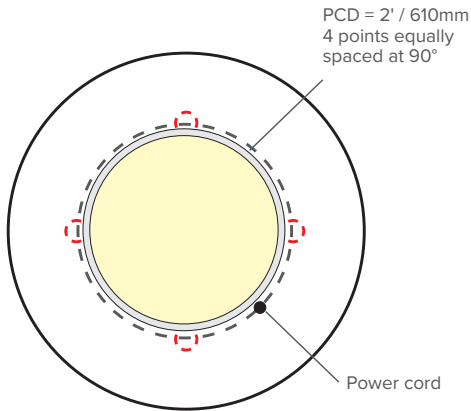

SIZE XL

45.3" / 1150mm

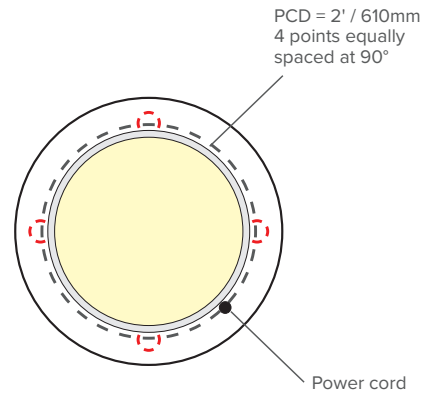

SIZE L

29.5" / 750mm

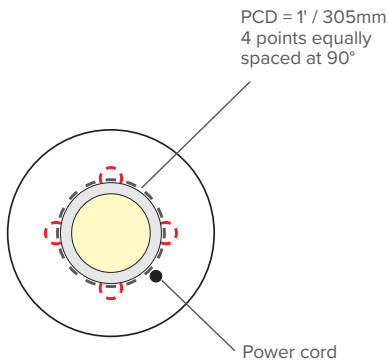

SIZE M

23" / 580mm

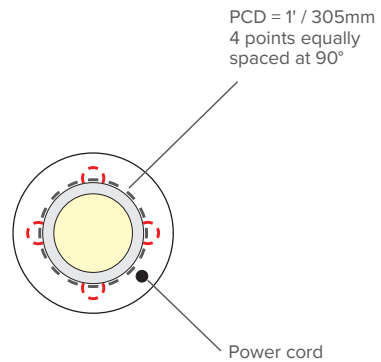

SIZE S

17.5" / 450mm

Luxbox reserves the right to change the specification, material and colors at any time without notice. Standard warranty terms and conditions apply. All rights reserved © All dimensions and values on specification sheet are nominal. February 2024. LX-Waffle-Pendant-Uplite-Spec-Sheet.V2



LUXXBOX USA INC × (P)+1 (415) 871 0448 × USA@LUXXBOX.COM
LUXXBOX PTY LTD × (P)+61 7 3257 2822 × INFO@LUXXBOX.COM
WWW.LUXXBOX.COM

