

TYPE:

## KEY FEATURES

- Highly effective noise absorption
- Perfect fit for corridors, hallways or above desks
- 4 lengths and a wide range of colors
- Mix and match shade colors and end cap finishes
- High performance dimmable LED light source - UGR<19
- Height adjustable 9' / 3m suspension cables and Black woven power cable
- IES photometric files available
- L70 lifetime rating of 50,000 hours

## OPTIONAL EXTRAS

- Additional options available upon request
- POE
  - Bluetooth controller (US & EU only)
  - Tunable White output
  - White canopy and power cord



## SIZE, OUTPUT AND WEIGHT

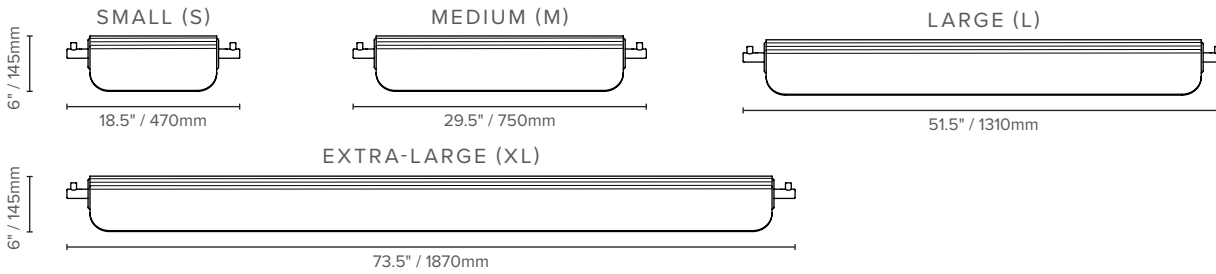

	SMALL			MEDIUM			LARGE			EXTRA LARGE		
	Delivered Lumens	Wattage	Efficacy	Delivered Lumens	Wattage	Efficacy	Delivered Lumens	Wattage	Efficacy	Delivered Lumens	Wattage	Efficacy lm/W
Direct Output	683lm	8.9W	77 lm/W	1245lm	16.3W	76 lm/W	2370lm	31W	76 lm/W	3495lm	45.6W	77 lm/W
Weight	13.2 lbs / 6 Kg			17.6 lbs / 8 Kg			22 lbs / 10 Kg			30.9 lbs / 14 Kg		

## ORDER CODE

EXAMPLE: LX - DA - L - DB - SL - 40 - UNV - RD

(Luxxbox Dasch, Large (52" / 1310mm), Dark Blue shade, Silver Anodized end caps, 4000K, Universal 110-277V / 0-10V dimming, Remote driver)

LX - DA	SIZE		SHADE COLOR	END CAP FINISH	COLOR TEMP		REGION / DIMMING		DRIVER TYPE	
DA	S	18.5" / 470mm	Use color codes as shown	Use color codes as shown	30	3000K	UNV	Universal 110-277VAC / 0 - 10V 10% dimming (North America only)	CD	Canopy concealed driver (UNV/North America only)
M	29.5" / 750mm	35			3500K	G				
L	52" / 1310mm	40			4000K		RD	Remote driver (UNV or G)		
XL	73.5" / 1870mm									

\* Global (G) dimming type is available with Remote driver (RD) only

## AVAILABLE COLORS

Colors are subject to lead times and variations across batches

### CORE

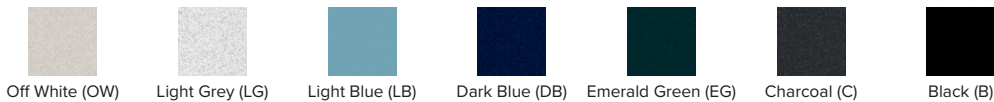

### DESIGNER



### END CAP

Anodized finishes

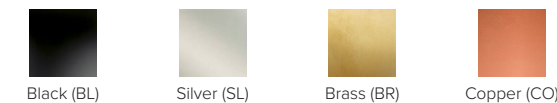

Luxxbox reserves the right to change the specification, material and colors at any time without notice. Standard warranty terms and conditions apply. All rights reserved © All dimensions and values on specification sheet are nominal. Color and pattern are for illustrative purposes only. Variation in pattern and alignment may occur from product to product. October 2023. LX-Dasch-HO-Spec Sheet v6.01



# DASCH (LX-DA)

TYPE:

## PHOTOMETRICS

	SMALL (18.5" / 470mm)	MEDIUM (29.5" / 750mm)	LARGE (52" / 1310mm)	EXTRA LARGE (74" / 1870mm)
Delivered Lumen Output	683lm	1245lm	2370lm	3495lm
Wattage	8.9W	16.36W	31W	45.6W
Efficacy	77 lm/W			
CRI	90+			
CCT	3000, 3500, 4000 K			
UGR	<19			

## LUMINOUS INTENSITY DISTRIBUTION

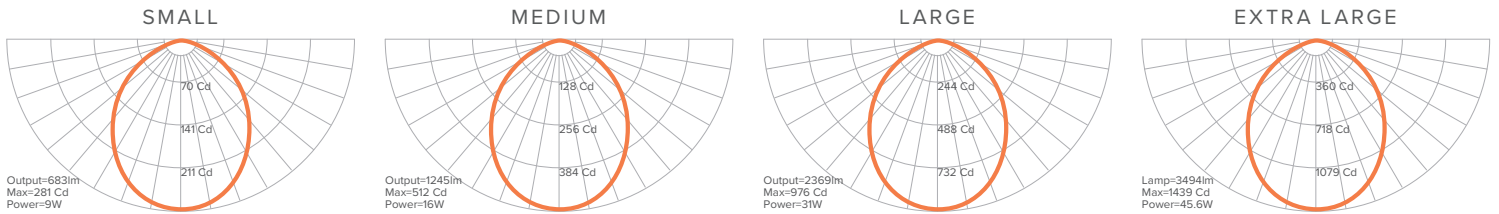

## DRIVER INFORMATION

10% DIMMING (120-277V)				
Size	Output	Watts	Output	Compliance
SMALL	Direct	8.9W	18-36VDC	CE            SELV Class 2
MEDIUM	Direct	16.36W		
LARGE	Direct	31W		
EXTRA LARGE	Direct	45.6W		

1% DIMMING (DALI) (220-240V)				
Size	Output	Watts	Output	Compliance
SMALL	Direct	8.9W	10-55VDC	CE            SELV RoHS
MEDIUM	Direct	16.36W		
LARGE	Direct	31W		
EXTRA LARGE	Direct	45.6W		

## CANOPY INFORMATION

Please note power cable and canopy will always be supplied in black unless specified otherwise.

PRODUCT	SIZE	UNIVERSAL (NORTH AMERICA)		GLOBAL
		RD	CD	RD
LX-DA	S/M/L	SA1	CD9	SB1
	XL	SA1	CD13	SB1

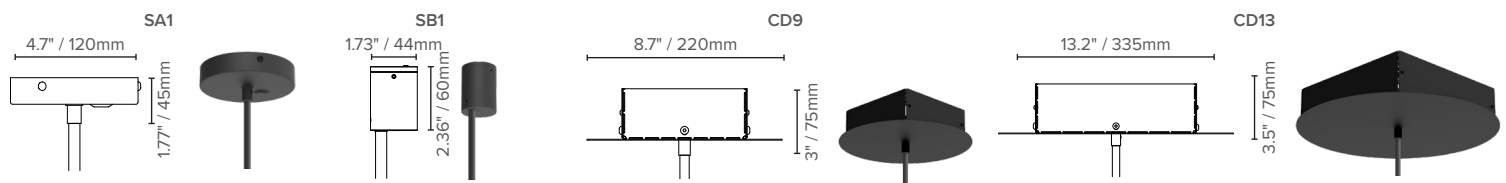

Luxbox reserves the right to change the specification, material and colors at any time without notice. Standard warranty terms and conditions apply. All rights reserved © All dimensions and values on specification sheet are nominal. Color and pattern are for illustrative purposes only. Variation in pattern and alignment may occur from product to product. October 2023. LX-Dasch-HO-Spec Sheet v6.01



LUXBOX USA INC × (P)+1 (415) 871 0448 × USA@LUXBOX.COM  
 LUXBOX PTY LTD × (P)+61 7 3257 2822 × INFO@LUXBOX.COM  
 WWW.LUXBOX.COM





# DASCH (LX-DA)

TYPE:

## MATERIAL SPECIFICATIONS

COLOR FASTNESS TO LIGHT:	ISO 105-B02-1994 Rating: 6-7
FIRE TEST:	AS 1530.3 / ISO 9705: Group 1 / GB8624 B1 / ASTM E-84-14 (Class A, FSI:20 - SDI:450) / BS EN13501-1:2007+A1:2009 (B-s1, d0)
ENVIRONMENTAL:	PET achieves GreenTag Certification / GreenRate: Level A
THERMAL TRANSITION:	ASTM C518-2010. R- Value = 0.30 m <sup>2</sup> K/W
SOUND ABSORPTION:	AS ISO 354 – 2006 / Noise reduction coefficient (NRC) = 0.85
VOC EMISSIONS:	ASTM D5116 Rate: < 0.01 mg/m <sup>2</sup> /hr (7 days)

Please note some of these certificates will apply to specific colors.

## PRODUCT ACOUSTIC PROPERTIES

Testing and post analysis procedures were carried out in accordance with the references detailed below:

AS ISO 354-2006 (R2016)	Acoustics—Measurement of sound absorption in a reverberation room
AS ISO 11654—2002	Rating of sound absorption—Materials and systems
ASTM C423-17	Standard Test Method for Sound Absorption and Sound Absorption Coefficients by the Reverberation Room Method
ASTM E795-16	Standard Practices for Mounting Test Specimens During Sound Absorption Tests
ISO 20189	Screens, furniture and single objects intended for interior use – Rating of sound absorption and sound reduction of elements based on laboratory measurements.

IMPERIAL SABINS

Frequency (Hz)	Sound Absorption Coefficient	SMALL (S)	MEDIUM (M)	LARGE (L)	EXTRA-LARGE (L)
125	0.06	0.03	0.05	0.11	0.21
250	0.33	0.17	0.25	0.59	1.13
500	0.73	0.37	0.55	1.30	2.51
1000	1	0.51	0.76	1.78	3.43
2000	0.96	0.49	0.73	1.71	3.29
4000	1	0.51	0.76	1.78	3.43

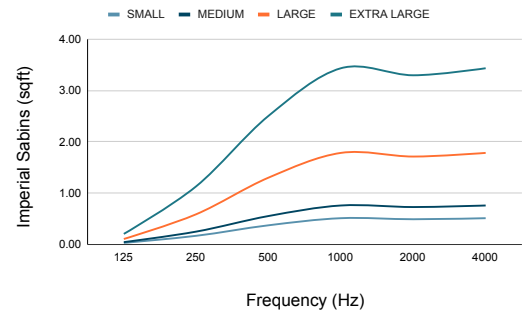

METRIC SABINS

Frequency (Hz)	Sound Absorption Coefficient	SMALL (S)	MEDIUM (M)	LARGE (L)	EXTRA-LARGE (L)
125	0.06	0.00	0.00	0.01	0.02
250	0.33	0.02	0.02	0.05	0.11
500	0.73	0.03	0.05	0.12	0.23
1000	1	0.05	0.07	0.17	0.32
2000	0.96	0.05	0.07	0.16	0.31
4000	1	0.05	0.07	0.17	0.32

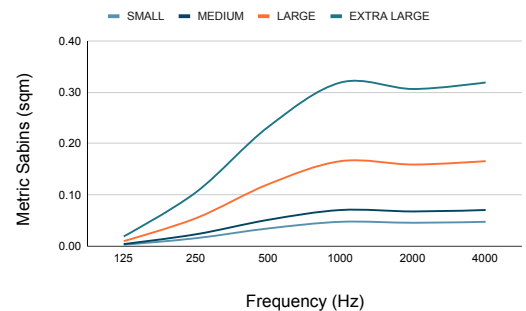

The Sabin data shown above is in accordance with the latest International Standards for the rating of sound absorption and reduction. This is different from the classic methodology, which includes the calculation of the Noise Reduction Coefficient (NRC), the Sound Absorption Average (SAA), the Weighted Sound Absorption Coefficient ( $\alpha_w$ ) and the Sound Absorption Class (SAC). However, to make it easier to compare against other products, we are including that information on the table on the right, which was calculated using the Horizontal Floor Area method. Fully detailed test reports are available upon request.

NRC	0.75
SAA	0.75
$\alpha_w$	0.6 (MH)

Luxbox reserves the right to change the specification, material and colors at any time without notice. Standard warranty terms and conditions apply. All rights reserved © All dimensions and values on specification sheet are nominal. Color and pattern are for illustrative purposes only. Variation in pattern and alignment may occur from product to product. October 2023. LX-Dasch-HO-Spec Sheet v6.01



LUXXBOX USA INC × (P)+1 (415) 871 0448 × USA@LUXXBOX.COM  
 LUXXBOX PTY LTD × (P)+61 7 3257 2822 × INFO@LUXXBOX.COM  
 WWW.LUXXBOX.COM





# DASCH (LX-DA)

TYPE:

## PRODUCT DIMENSIONS

### SIDE VIEWS

### END VIEW

#### SMALL

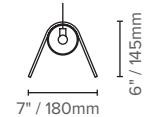
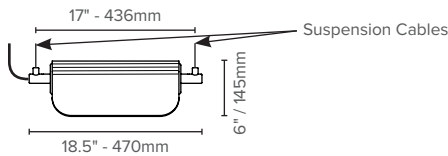

#### MEDIUM

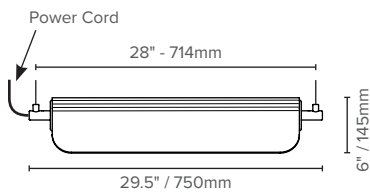

#### LARGE

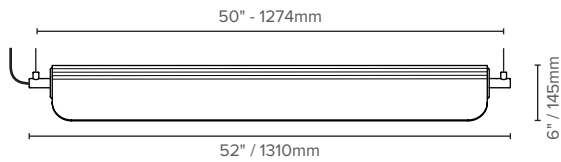

#### EXTRA-LARGE

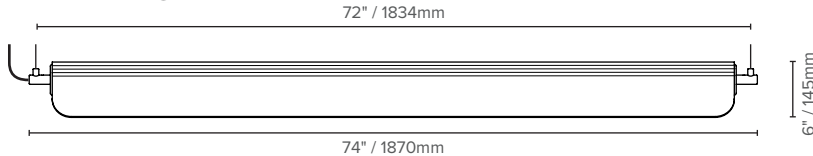

### EXAMPLE: SUSPENSION - POWER

On the side views above you can see the power cable will always exit the pendant through the side of the pendant, very close to the suspension cable.

Canopies are not supplied with suspension points, so our recommended method of installation is shown on the diagram on the right.

You will find more detailed information about the canopy on page 3 or refer to the Installation Instructions at [www.luxxbox.com](http://www.luxxbox.com).

### Recommended Installation

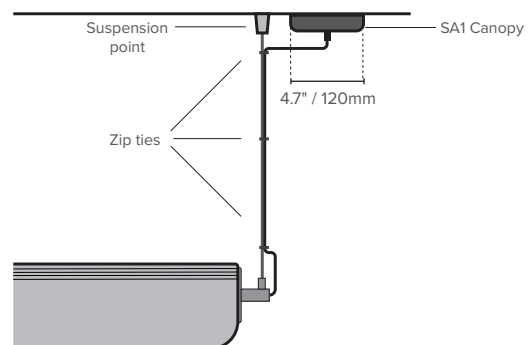

Luxxbox reserves the right to change the specification, material and colors at any time without notice. Standard warranty terms and conditions apply. All rights reserved © All dimensions and values on specification sheet are nominal. Color and pattern are for illustrative purposes only. Variation in pattern and alignment may occur from product to product. October 2023. LX-Dasch-HO-Spec Sheet v6.01



LUXXBOX USA INC × (P)+1 (415) 871 0448 × USA@LUXXBOX.COM  
LUXXBOX PTY LTD × (P)+61 7 3257 2822 × INFO@LUXXBOX.COM  
WWW.LUXXBOX.COM

