



TYPE:

KEY BENEFITS

- Wedge ThoughtBoard forms part of Luxxbox's agile whiteboard range
- Superior quality ceramic steel surface for streak-free writing
- Choice of laminate backing
- Use multiple ThoughtBoards to create a straight or curved room divider
- High quality lockable castors for ease of movement, concealed to remove trip hazard
- Ships flat, easy to assemble, short lead times
- Optional acoustic board for sound absorption to dampen noise
- Acoustic board available in the MOTIF collection
- Magnetic surface hosts a suite of collaborative accessories
- Non-magnetic option available
- All versions include internal shelf
- Only GECA certified agile whiteboard on the market

ORDER CODE

EXAMPLE: LX - WTB - YM - W - B

(Luxxbox Wedge ThoughtBoard, Magnetic, White, Black Edges)

LX - WTB	MAGNETIC		INTERIOR COLOR		EDGE COLOR	
PRODUCT CODE	YM	Yes	O	Oak Veneer	B	Black
WTB	NM	No*	B	Black Veneer	W	White
			W	White		

(*Warranty terms for non-magnetic option differs from magnetic)

EXAMPLE: LX - WTX - PH

(Luxxbox Wedge ThoughtBoard Accessory, Pen Holder)

EXAMPLE: LX - WTX - BL - BY

(Luxxbox Wedge ThoughtBoard Accessory, Large Acoustic Board, Bright Yellow color)

LX - WTX	OPTIONAL ACCESSORIES		OPTIONAL ACCESSORIES	
PRODUCT CODE	FL	Flip Chart Bracket (Large)	BS	Small Acoustic Board***
WTX	PH	Pen Holder**	BL	Large Acoustic Board***
	BT	Base Tray		
	ES	External Shelf**		

(**Pen Holder and External Shelf are only available for the Magnetic option)

(*** To Specify Acoustic Board color use color codes below)

SIZE

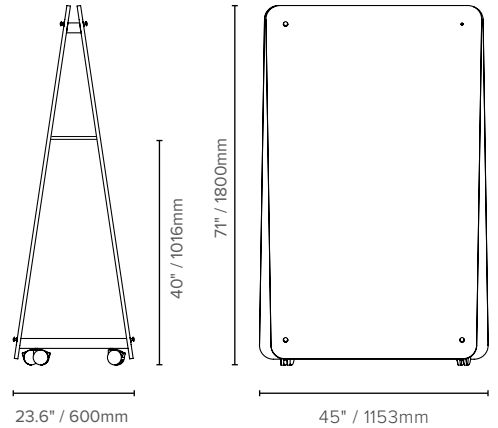

DIVIDER EXAMPLES

Straight room divider

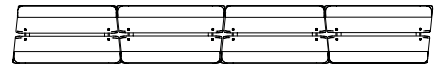

Curved room divider

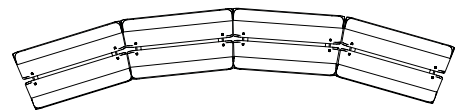

AVAILABLE COLORS

Colors are subject to lead times and variations across batches

INTERIOR COLOUR



Oak veneer (O)



Black veneer (B)



White (W)

EDGE COLOUR



White (W)



Black (B)

ACOUSTIC BOARD COLOUR

CORE



Off White (OW)



Light Grey (LG)



Light Blue (LB)



Dark Blue (DB)



Emerald Green (EG)



Charcoal (C)



Black (B)

DESIGNER



Sand (SA)



Mid Grey (MG)



Bright Blue (BB)



Steel Blue (SB)



Forest Green (FG)



Bright Yellow (BY)



Orange (O)



Red (R)

Luxxbox reserves the right to change the specification, material and colors at any time without notice. Standard warranty terms and conditions apply. All rights reserved © All dimensions and values on specification sheet are nominal. All dimensions and values on specification sheet are nominal. Thoughtboard's panels may change shape slightly over time, it is a natural movement due to changing temperature and humidity conditions. It will in no way affect performance or function. June 2023. LX-Wedge-Thoughtboard-Spec-Sheet v6.2



WEDGE THOUGHTBOARD (LX-WTB)

ACCESSORIES

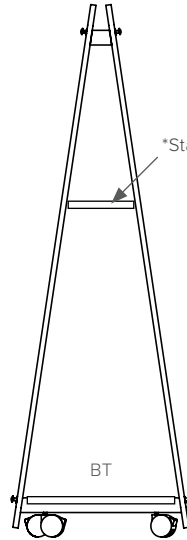
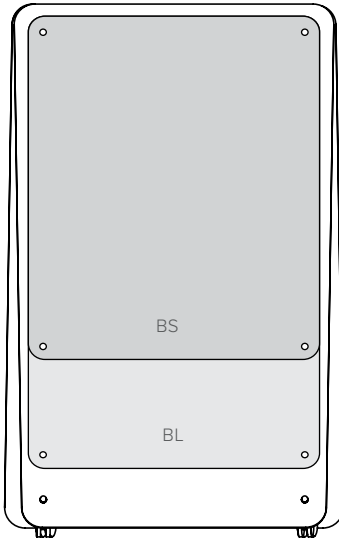

*Standard Internal Shelf

*The Standard Internal Shelf always comes in white with edges matching the boards. Other options are available upon request.

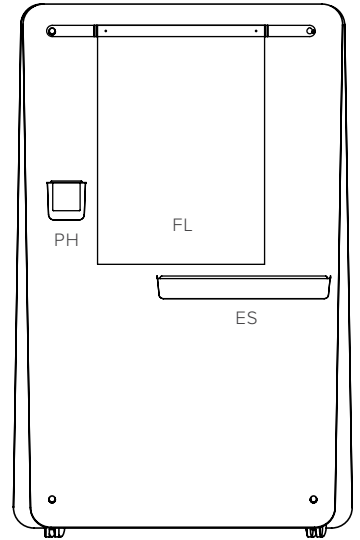

(BS) SMALL ACOUSTIC BOARD

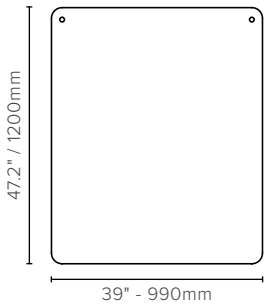

(BL) LARGE ACOUSTIC BOARD

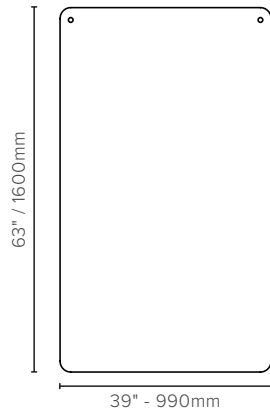

(FL) FLIP CHART BRACKET

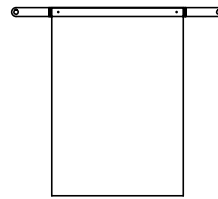

Standard color: White

(PH) PEN HOLDER

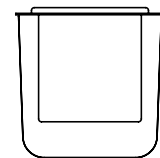

Standard color: White
(only available for the magnetic option)

(BT) BASE TRAY



Standard color: Black

(ES) EXTERNAL SHELF

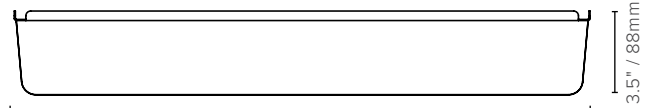

Standard color: White
(only available for the magnetic option)

Luxxbox reserves the right to change the specification, material and colors at any time without notice. Standard warranty terms and conditions apply. All rights reserved © All dimensions and values on specification sheet are nominal. All dimensions and values on specification sheet are nominal. Thoughtboard's panels may change shape slightly over time, it is a natural movement due to changing temperature and humidity conditions. It will in no way affect performance or function. June 2023. LX-Wedge-Thoughtboard-Spec-Sheet v6.2



LUXXBOX USA INC × (P)+1 (415) 871 0448 × USA@LUXXBOX.COM
LUXXBOX PTY LTD × (P)+61 7 3257 2822 × INFO@LUXXBOX.COM
WWW.LUXXBOX.COM

