

HFA

RETREAT FOCUS

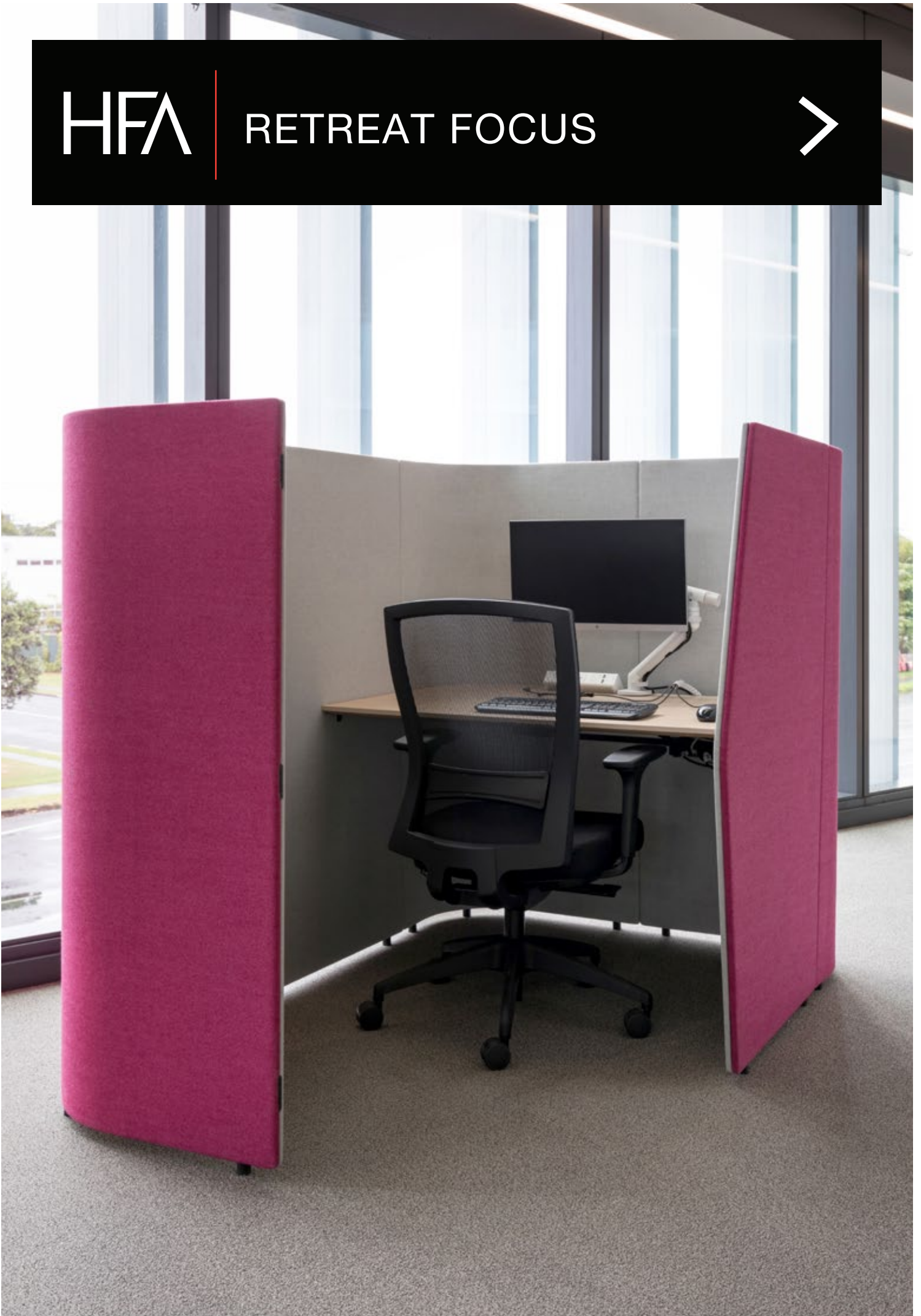

Need to escape from the interruptions and distractions at your desk?

Our versatile Retreat Focus range creates quiet areas within the open plan office that allow you to concentrate, be more productive and get work done.





# Retreat

---

## Focus

---

Retreat Focus is a versatile range of free-standing pods and screens which support agile work throughout the open-plan office. The range is available in a variety of configurations to meet the demand for individual focus or collaborative focus work.

As a modular system, each setting is made from a wide-ranging kit of parts. Panels clip together using our unique hidden connection system, which allows future reconfiguration if required. Upholstered wall panels combine with worktops to offer a cost-effective, flexible alternative to permanent quiet rooms or offices.

Because we live in a world of portable electronic devices, you can choose to have power, data, HDMI and USB all integrated into the booth. Power and data can either be fed from the floor or from the ceiling.

Choose from curved or straight walls – the Retreat range offers variety while still retaining a similar design language throughout a space.

Retreat is designed and manufactured in New Zealand and can be easily customised according to your needs. All that's left to do is choose a colour and fabric to suit your interior style.





# Retreat

## Focus

### FEATURES

#### Dimensions

Standard screen height is 1350H

Booth widths are based off standard top widths of 1200W, 1400W, 1600W, 1800W and 2000W

#### Configurations

Straight single, side by side, zig zag or back to back settings

Straight or Hex pods

#### Options

Curved or Square corners

Envelope or Straight (except Hex) shaped end screens

Modular kit of parts, screens are reconfigurable

Fully upholstered screens with foam backing. Available in a variety of 1370W+ fabrics with different colours/fabrics on each side.

Integrated fixed height worktops as standard

Melamine, veneer, or timber worktops

Under desktop cable management tray, optional cable sling and cable sleeve

Range of integrated power/data options to choose from

Optional accessory hooks for hanging toolboxes, whiteboards and other accessories

10 year warranty



Single - Curved corners, Envelope ends



2 Side by Side - Curved corners, Envelope ends



2 Zig Zag - Curved corners, Envelope ends



Single - Square corners, Envelope ends

Pod - Curved corners, Envelope ends



2 Back to Back - Square corners, Envelope ends

Hex Single - Curved corners, Straight ends



2 Side by Side - Square corners, Envelope ends

Hex Pod - Curved corners, Envelope ends









# Retreat

## Focus

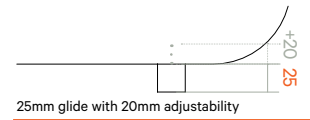

Glide detail

CURVED CORNERS

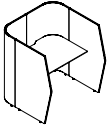

RF-S-XXXX-EE  
Envelope Ends

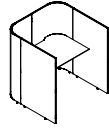

RF-S-XXXX-SS  
Straight Ends

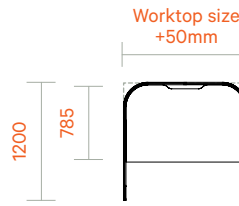

SQUARE CORNERS

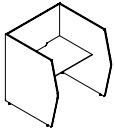

RF-S-XXXX-EE-SQ  
Envelope Ends

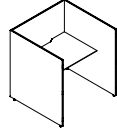

RF-S-XXXX-SS-SQ  
Straight Ends

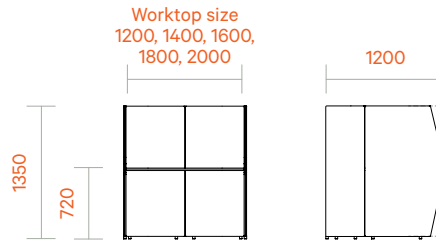

## Single

CURVED CORNERS

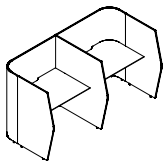

RF-SS-2-XXXX-E  
Envelope Ends

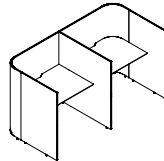

RF-SS-2-XXXX-S  
Straight Ends

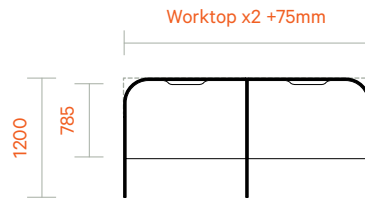

SQUARE CORNERS

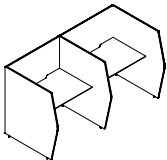

RF-SS-2-XXXX-E-SQ  
Envelope Ends

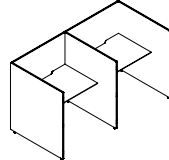

RF-SS-2-XXXX-S-SQ  
Straight Ends

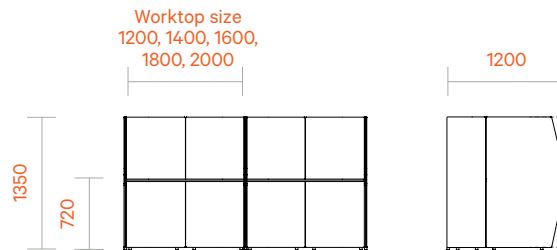

## 2 Side by Side

CURVED CORNERS

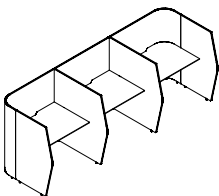

RF-SS-3-XXXX-E  
Envelope Ends

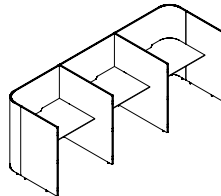

RF-SS-3-XXXX-S  
Straight Ends

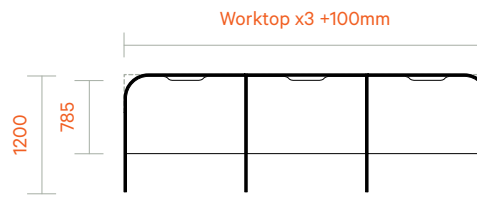

SQUARE CORNERS

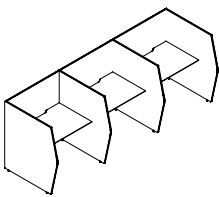

RF-SS-3-XXXX-E-SQ  
Envelope Ends

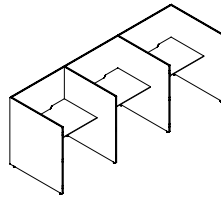

RF-SS-3-XXXX-S-SQ  
Straight Ends

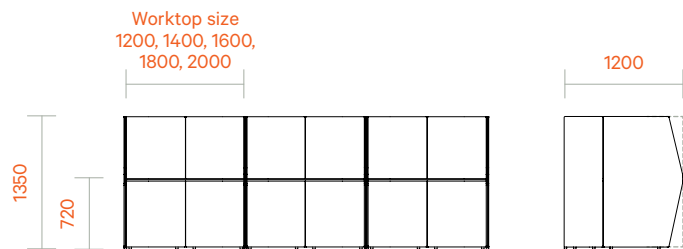

## 3 Side by Side

CODE NOTES:

XXXX = Worktop size 1200/1400/1600/1800/2000

Add -P1, -P2, -P3 to end of code if integrated power required. Refer to Power Options for descriptions.

# Retreat

## Focus

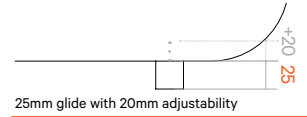

Glide detail

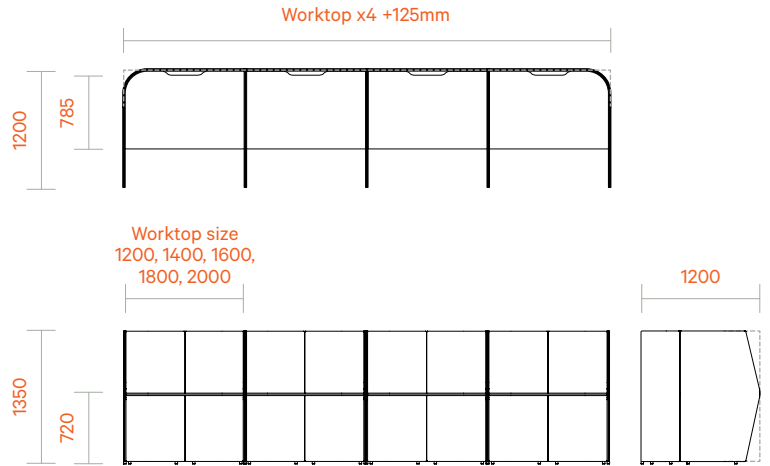
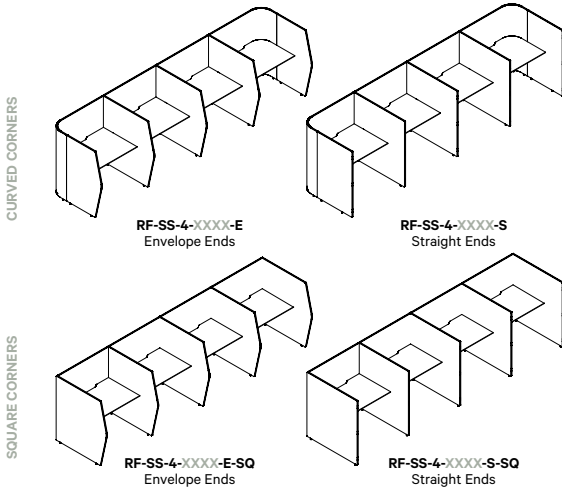

### 4 Side by Side

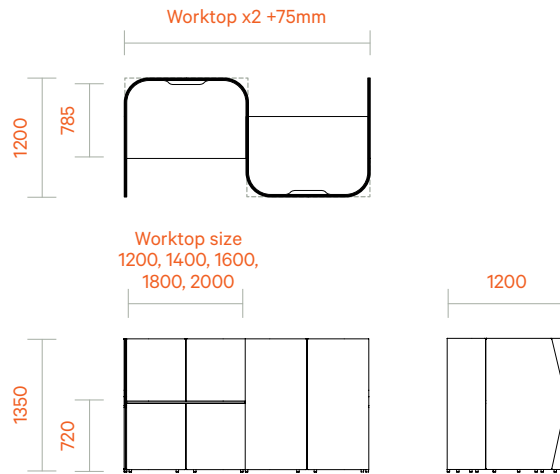
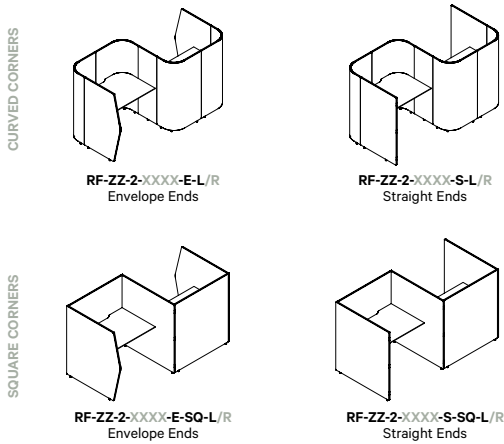

### 2 Zig Zag

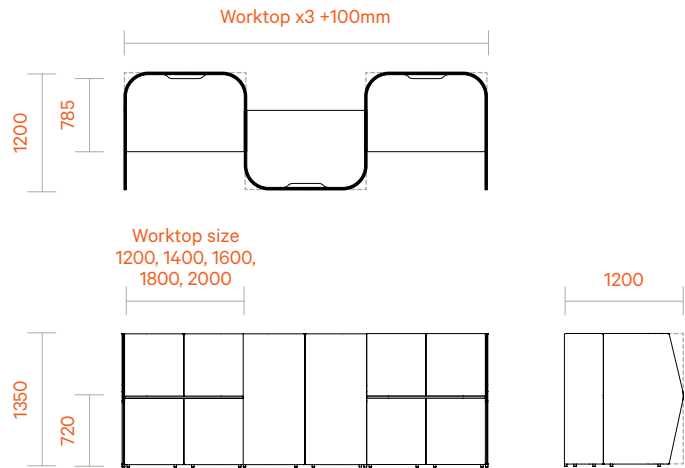
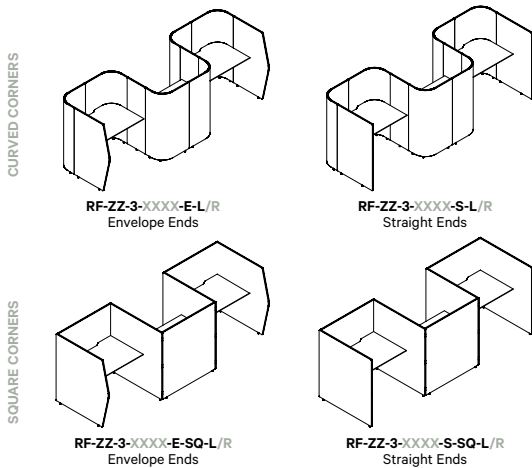

### 3 Zig Zag

CODE NOTES:  
XXXX = Worktop size 1200/1400/1600/1800/2000  
-L = Left hand entry  
-R = Right hand entry  
(Left hand entry shown in drawings)

Add -P1, -P2, -P3 to end of code if integrated power required. Refer to Power Options for descriptions.





# Retreat

## Focus

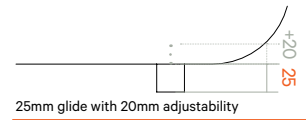

Glide detail

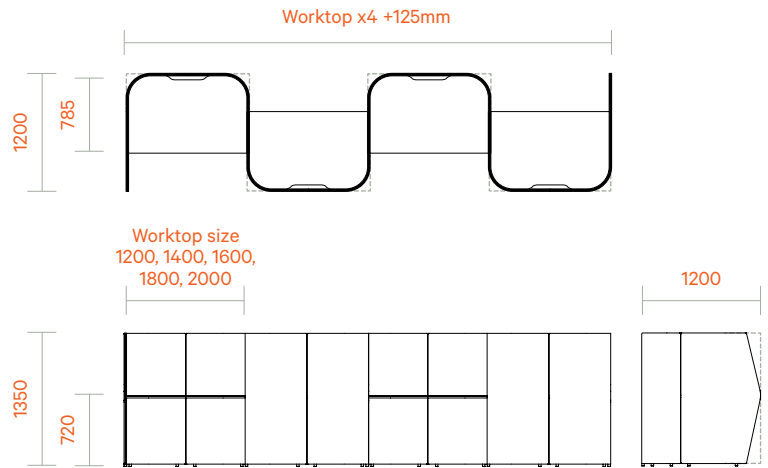
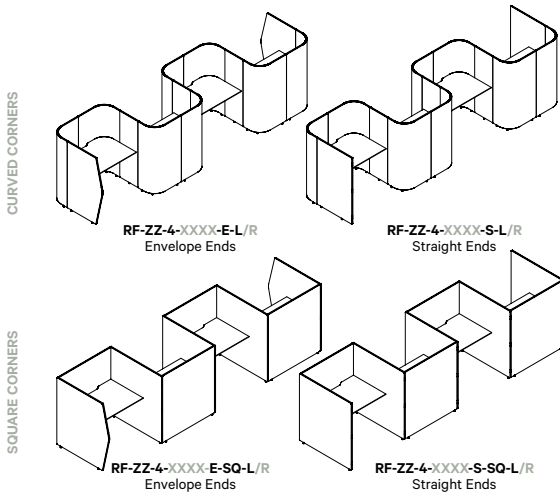

### 4 Side by Side

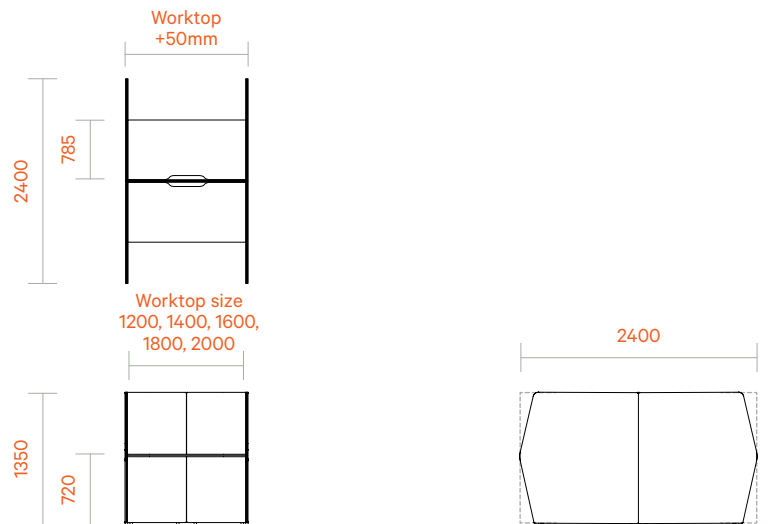
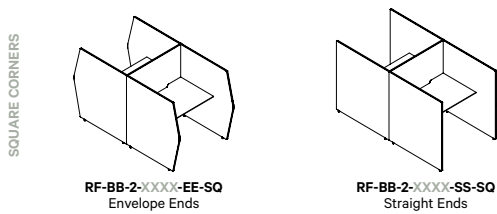

### 2 Back to Back

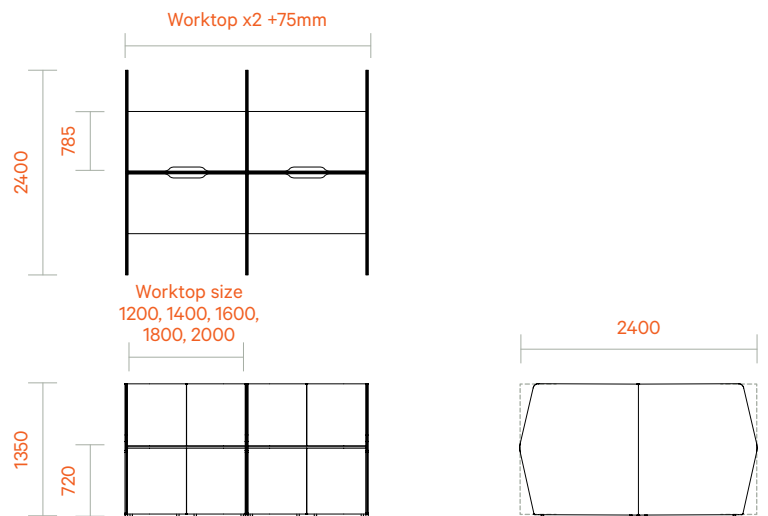
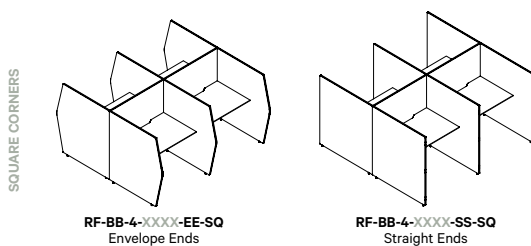

### 4 Back to Back

CODE NOTES:  
XXXX = Worktop size 1200/1400/1600/1800/2000  
-L = Left hand entry  
-R = Right hand entry  
(Left hand entry shown in drawings)  
Add -P1, -P2, -P3 to end of code if integrated power required. Refer to Power Options for descriptions.

# Retreat

## Focus

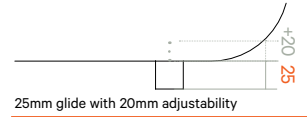

Glide detail

SQUARE CORNERS

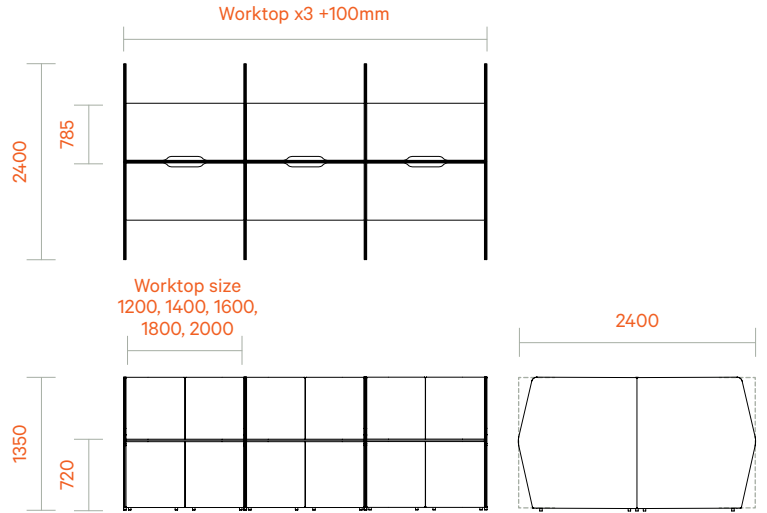
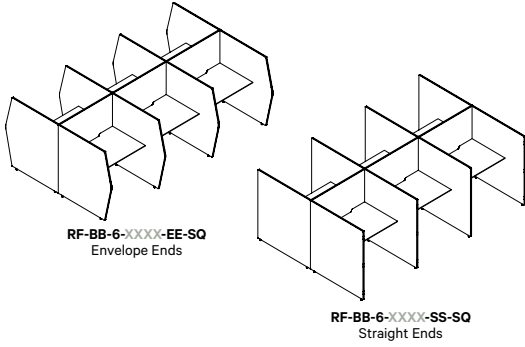

### 4 Side by Side

CURVED CORNERS

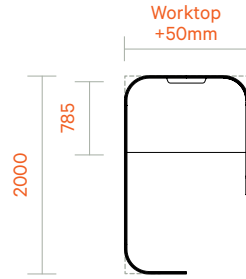
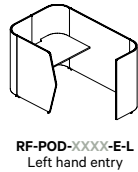

SQUARE CORNERS

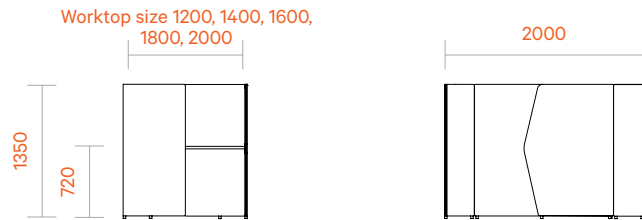

### Pod

CURVED CORNERS

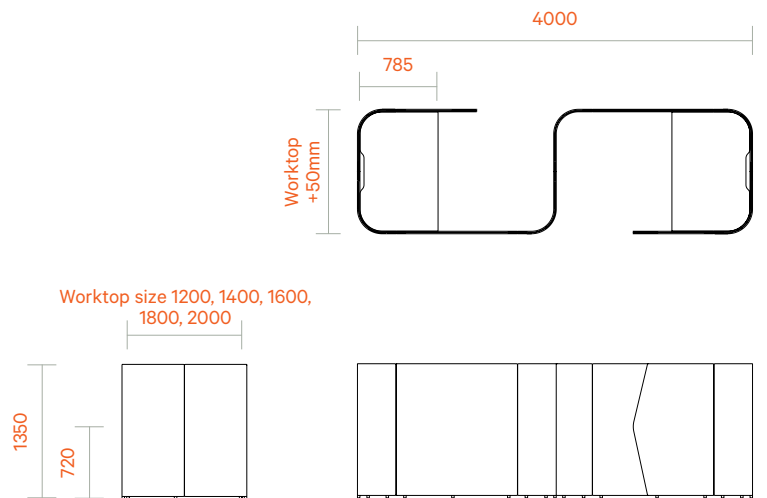
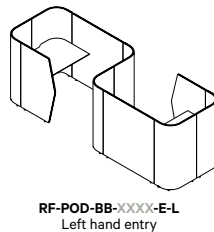
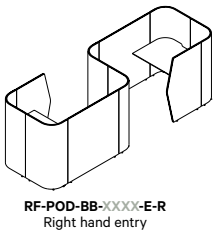

### Pod Back to Back

CODE NOTES:  
XXXX = Worktop size 1200/1400/1600/1800/2000  
Add -P1, -P2, -P3 to end of code if integrated power required. Refer to Power Options for descriptions.



# Retreat

## Focus

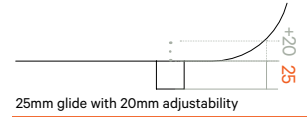

### Glide detail

CURVED CORNERS

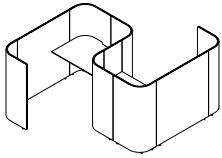

**RF-POD-ZZ-XXXX-E-R**  
Right hand entry

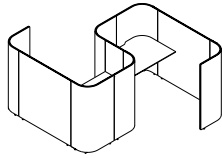

**RF-POD-ZZ-XXXX-E-L**  
Left hand entry

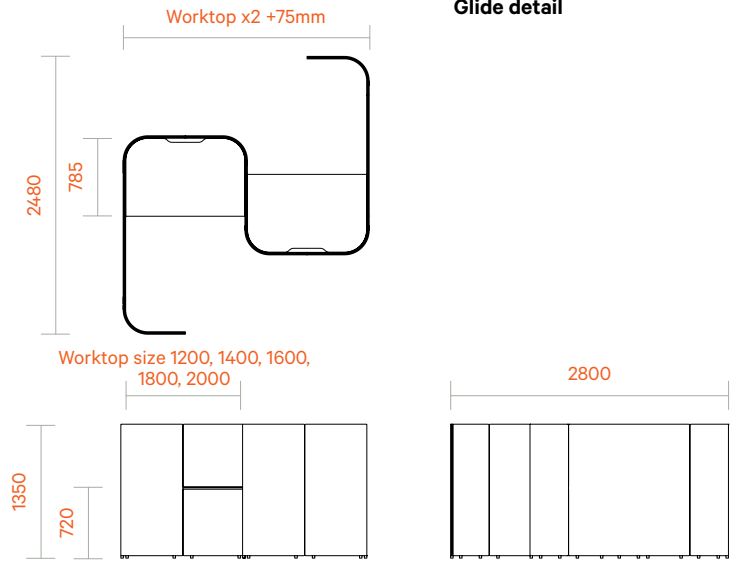

## Pod Zig Zag

CURVED CORNERS

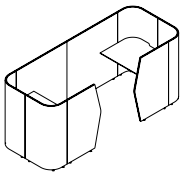

**RF-POD-DUO-XXXX-E**

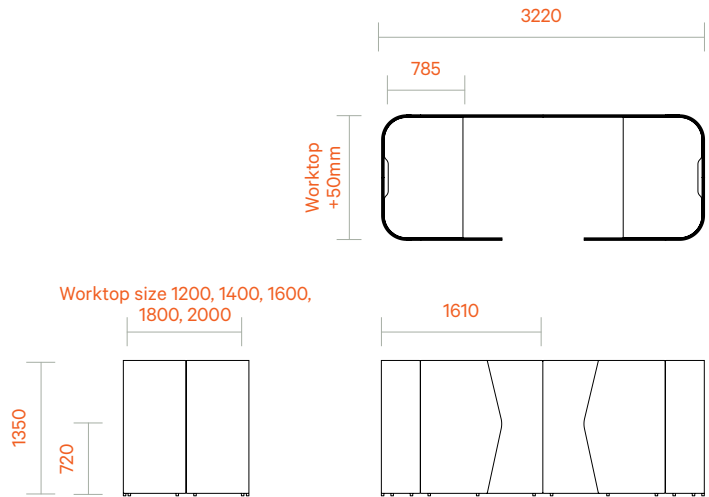

## Pod Duo

CURVED CORNERS

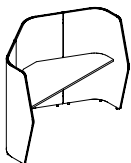

**RF-HEX-S-E**  
Envelope Ends

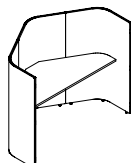

**RF-HEX-S-S**  
Straight Ends

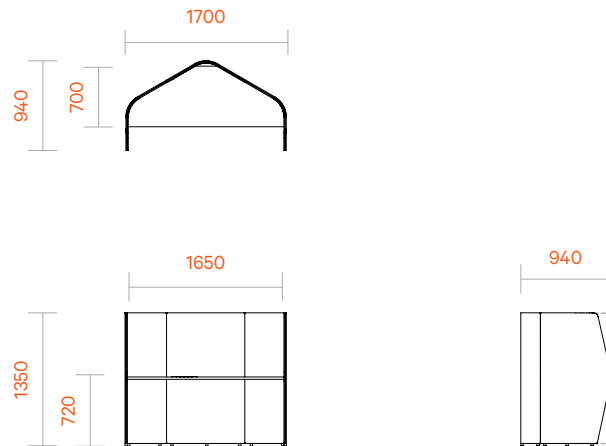

## Hex Single

CODE NOTES:  
XXXX = Worktop size 1200/1400/1600/1800/2000  
Add -P1, -P2, -P3 to end of code if integrated power required. Refer to Power Options for descriptions.



# Retreat

## Focus

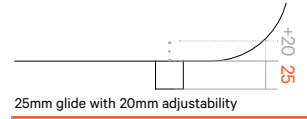

### Glide detail

CURVED CORNERS

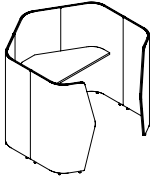

**RF-HEX-POD-E-C**  
Envelope Ends

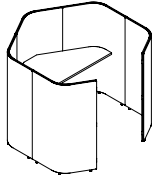

**RF-HEX-POD-S-C**  
Straight Ends

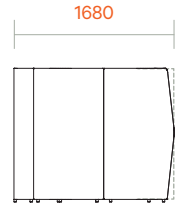
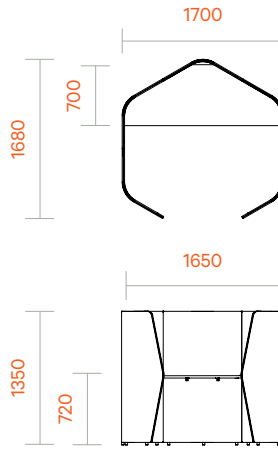

### Hex Pod Centre

CURVED CORNERS

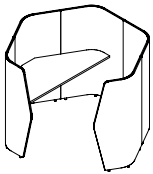

**RF-HEX-POD-E-L**  
Envelope Ends

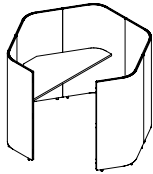

**RF-HEX-POD-S-L**  
Straight Ends

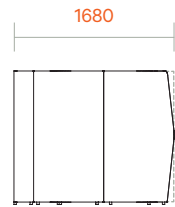
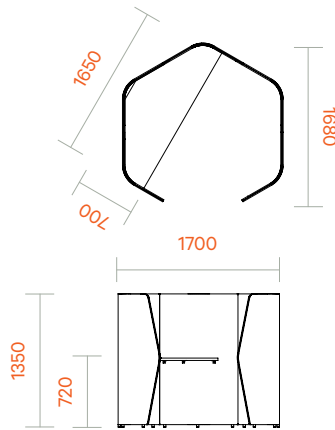

### Hex Pod Left

CURVED CORNERS

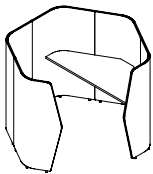

**RF-HEX-POD-E-R**  
Envelope Ends

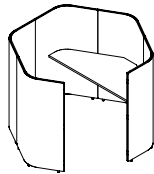

**RF-HEX-POD-S-R**  
Straight Ends

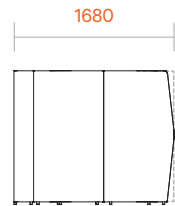
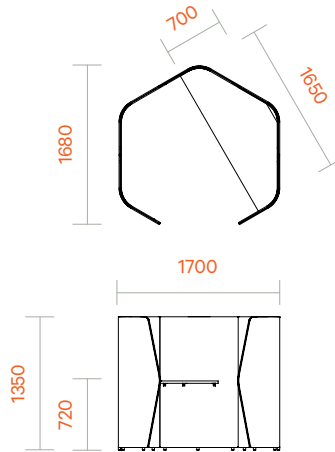

### Hex Pod Right

CODE NOTES:  
XXXX = Worktop size 1200/1400/1600/1800/2000  
Add -P1, -P2, -P3 to end of code if integrated power required. Refer to Power Options for descriptions.





# Retreat

## Focus

### Integrated Power Options



Konex US - 1x power + optional data, HDMI + USB



Cable port cover

Quantum Wireless Charger

#### P1 - 1x Echo Duo per worksetting

Echo Duo can have any 2 of the following in White or Black:

- Power outlet
- Fastcharge USB A+C
- Wireless charging
- Grommet cover for pulling through cable

#### P2 - 1x 80mm diameter hole per worksetting

To be used with one of the following:

- 1x 80mm Cable port cover
- 1x Konex US
- 1x Quantum wireless charging



#### P3 - 1x Echo Trio per worksetting

Echo Trio can have any 3 of the following in White or Black:

- Power outlet
- Fastcharge USB A+C
- Wireless charging
- Grommet cover for pulling through cable

#### Athena rail

Not integrated into top but clamps onto back edge of scallop in standard tops. Athena rails can have any of the following in White or Black:

- 1, 2 or 4 Power outlet
- Wireless charging
- USB A/C charging



# Retreat

## Focus

### Top Dimensions + Integrated Power Locations

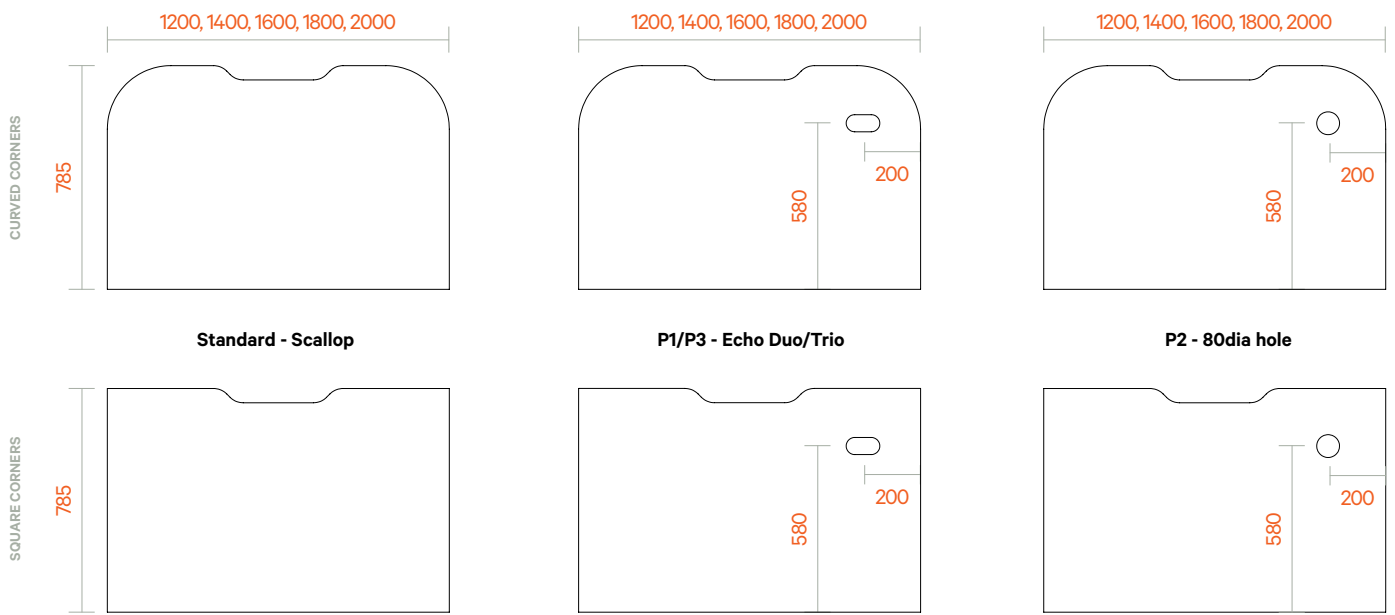

### Straight tops

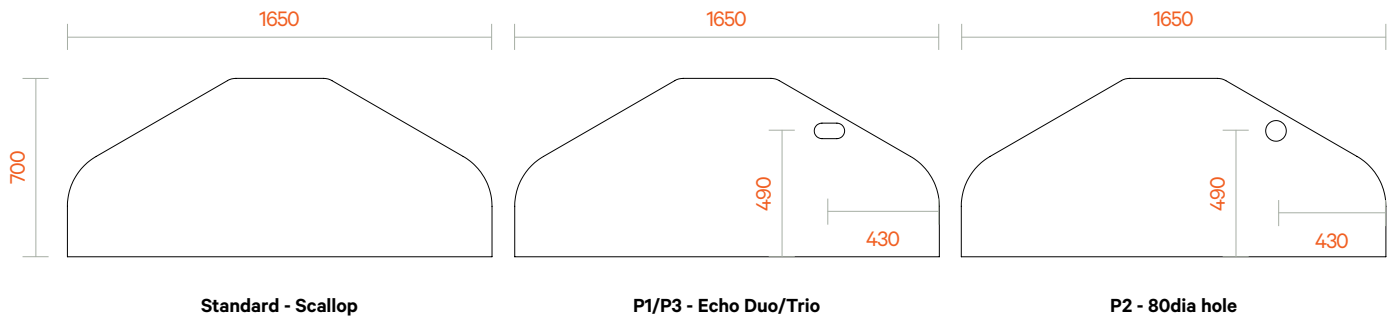

### Hex tops



# Retreat

## Focus

### Cable Management

#### FEATURES

Each Retreat Focus worktop includes an under-desk cable tray for managing cables and mounting up to 6x power outlets

##### **Underdesk Cable Tray:**

Powdercoated steel unit is mounted to the underside of the desk. All power cords and cables plug into this unit. The cable tray has ability to add up to 6x power outlets and up to 4x data outlets as well as slots along the length to allow for Velcro or cable ties to keep the cables in place.

##### **Optional Cable Sling and Sleeve:**

Provides streamlined cable management for cables underneath the desktop, power outlets are also mounted to the underside of the desktop. Cable sleeve is used to bring power to the cable tray/sleeve and up to the desktop

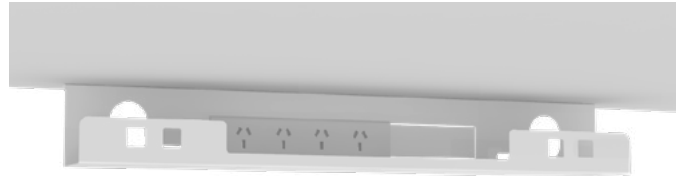

**Underdesk front facing cable dump tray (under desktop)**



**Optional Cable sling (under desktop)**

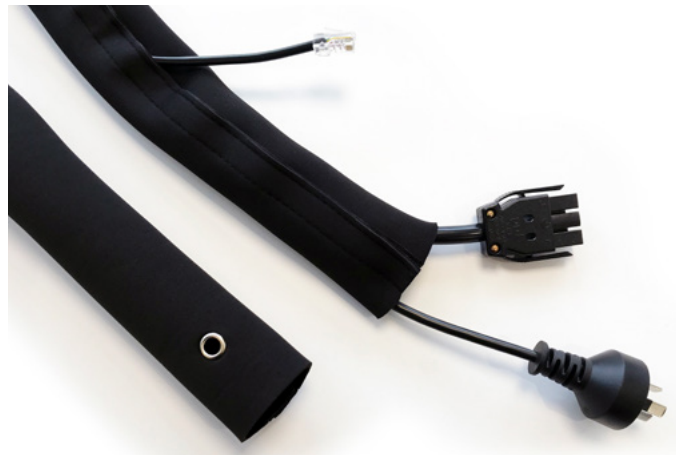

**Optional Cable sleeve**



# Retreat

## Focus

### Finishes + Accessories

#### FINISHES

##### Screens

Upholstery in any 1370W+ foam backed fabric  
Fabric is run sideways

##### Worktops

25mm laminate or veneer finish, square edges

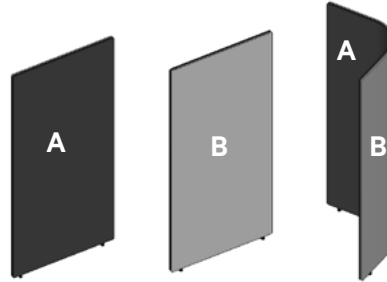

##### Upholstery Configuration:

- A Fabric
- B Fabric

On a curve A is the inside of the curve and B is the outside.

#### ACCESSORIES

Solid Brass or Black anodised aluminium Retreat Wall Hook to hang personal items. See position options below

Retreat toolbox made of steel with a solid oak handle. Powder coated in various colours.

Retreat circular whiteboard Ø360mm

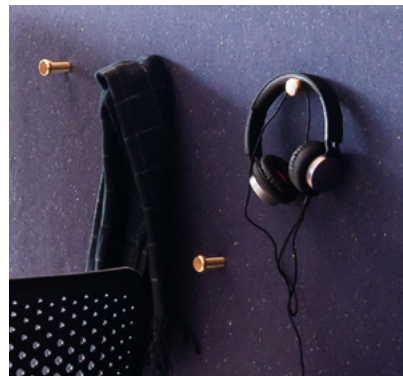

##### Accessory Hook Locations

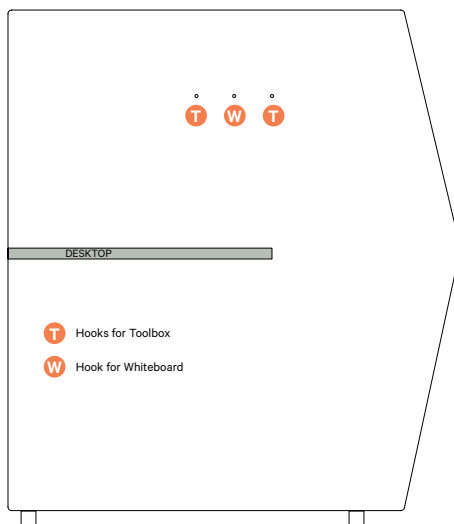

##### Retreat wall hooks



Retreat toolbox **T**



Retreat circular whiteboard ø360mm **W**





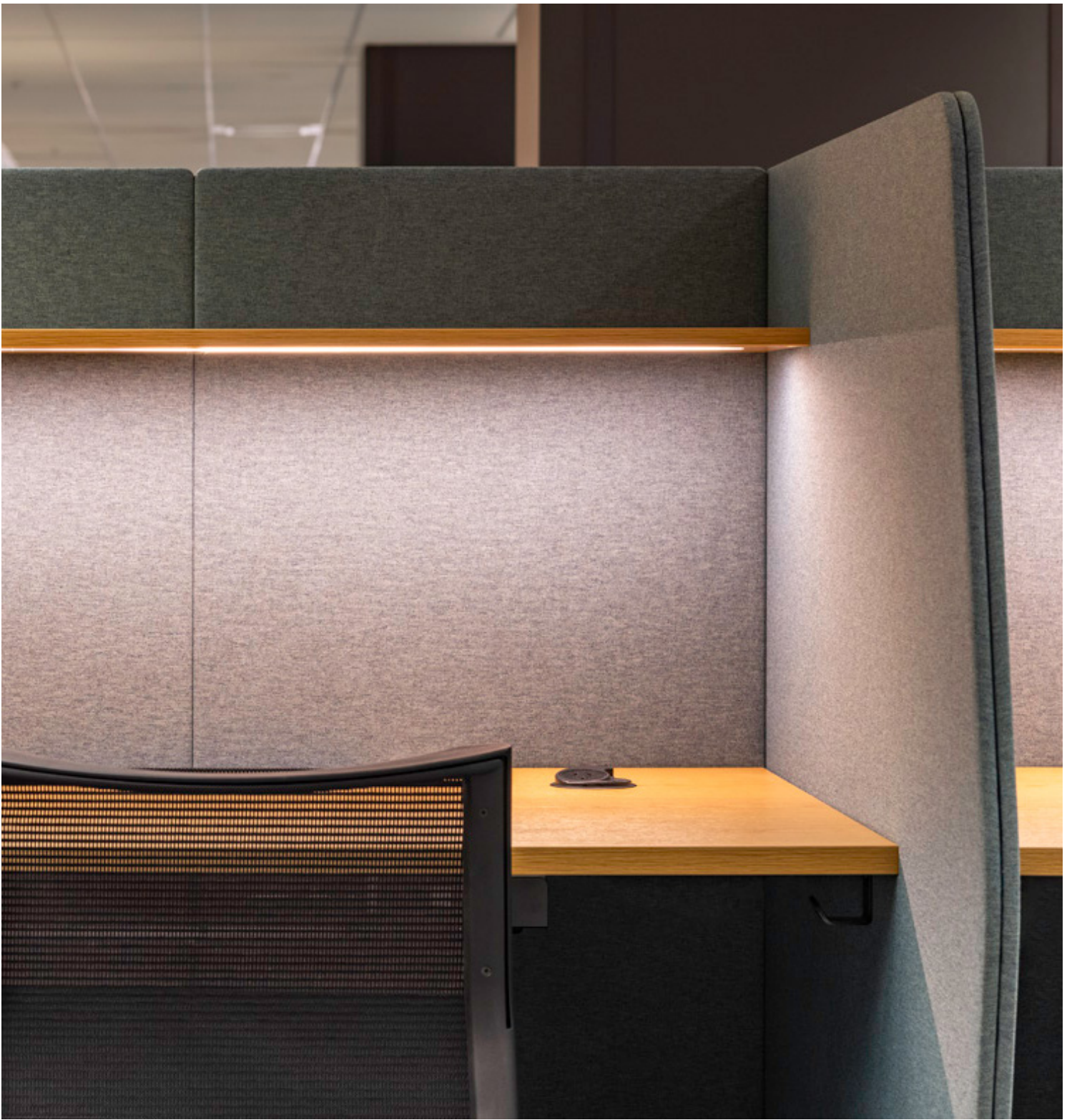



HFA



1F Marine Parade  
Abbotsford, Victoria  
3067 Australia

T +61 (3) 9818 8400  
F +61 (3) 9818 6655  
info@hfa.com.au

 ecf.com.au  
 ecf.hfa  
 @ecf\_hfa

