

ecf

RETREAT WALL

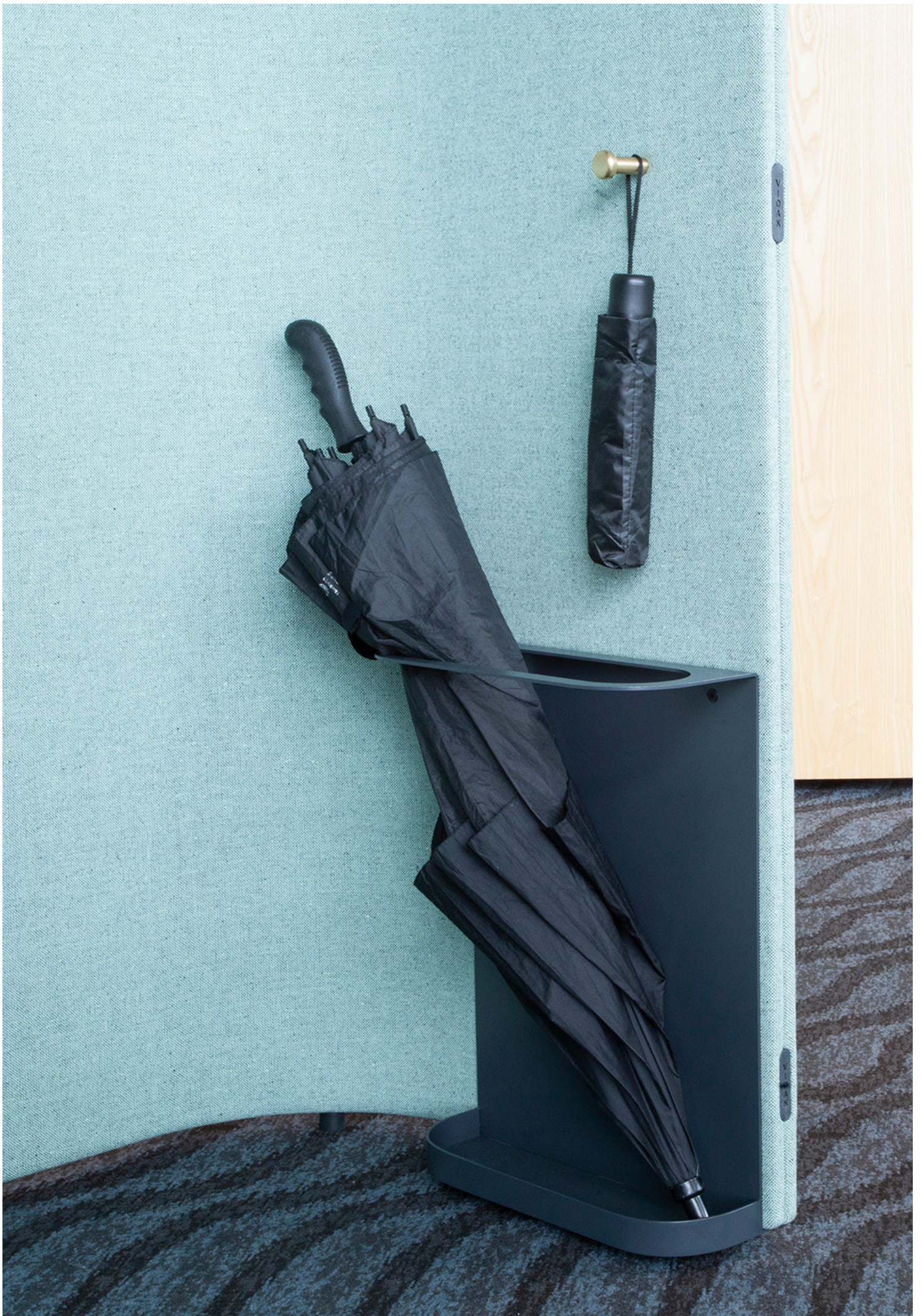







# Retreat

## Wall

### FEATURES

A multi-functional, acoustic screen to divide spaces within your office. Modular kit of parts which allows future reconfiguration.

#### Dimensions

1800H. Dimensions will vary according to modules

#### Accessories

Shelves, planter shelves, coat rails, wall hooks and umbrella stand

Fully upholstered screens with foam backing in your choice of fabric

Adjustable levelling glides

Can be used in conjunction with Retreat Workshop

Designed in New Zealand, made in Australia

ISO14001

10 year warranty

6-8 week lead time



Retreat Wall corner panels with and without shelves



Retreat Wall with coat rail and umbrella stand bay



Retreat Wall with coat bay and corner with planter shelves

# Retreat

## Wall

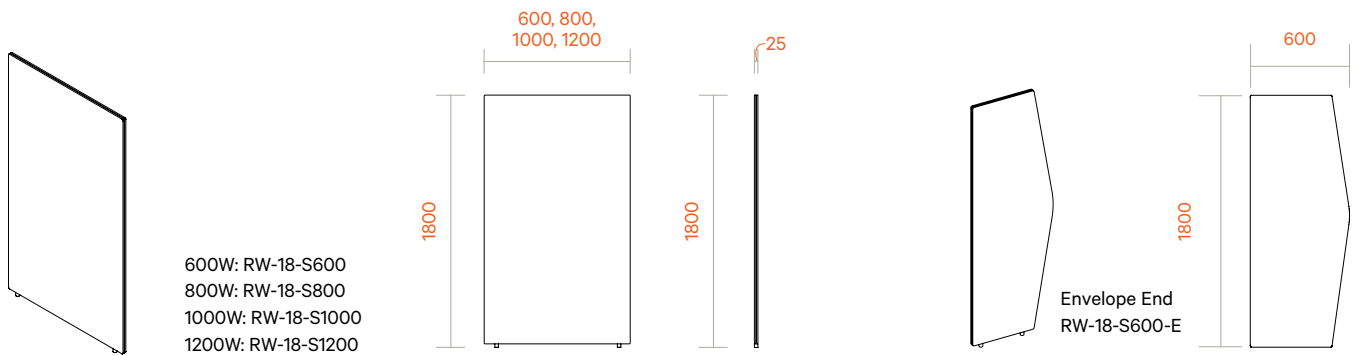

### Retreat Wall - Straight upholstered panels - NB: Straight panels must be used with a corner panel

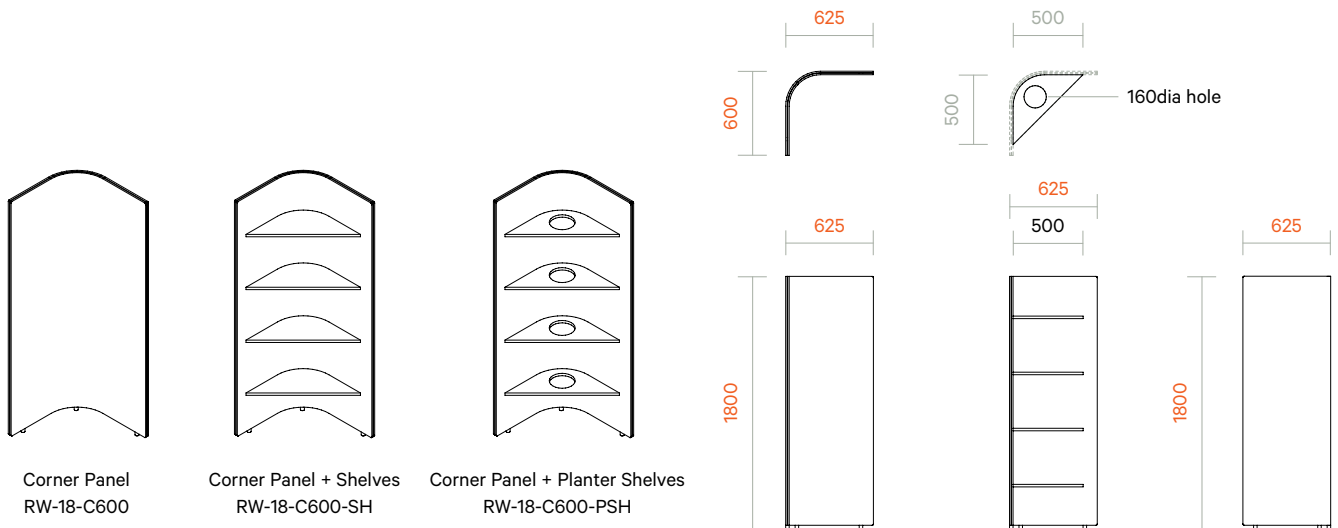

### Retreat Wall - Corner upholstered panels

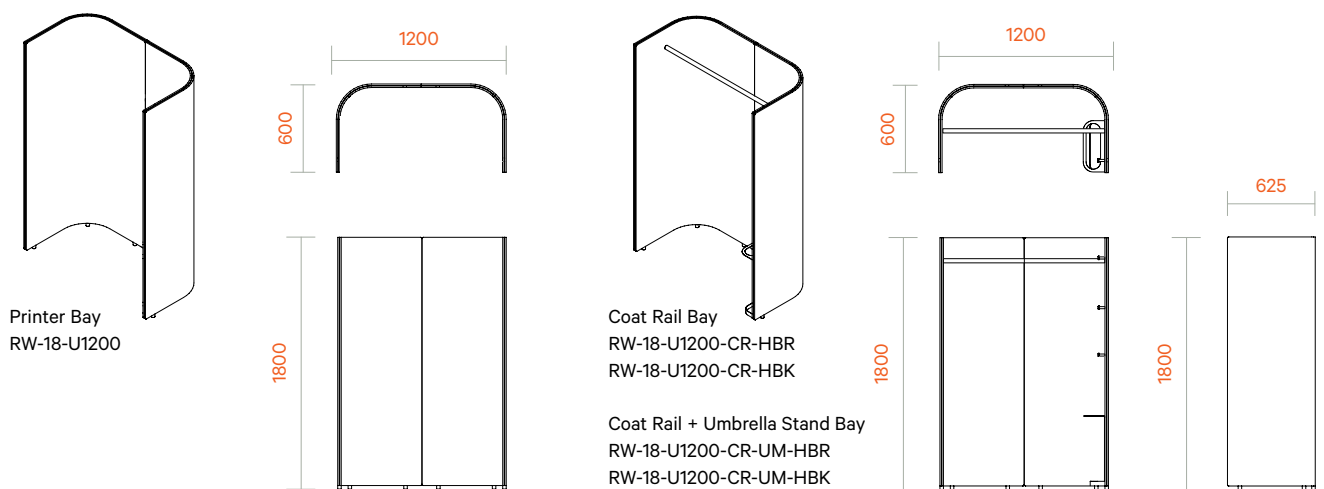

Both versions come with 3x Brass (HBR) or Black (HBK) hooks

### Retreat Wall - Printer Bay / Coat Rail + Umbrella Stand Bay

# Retreat

## Wall

### Accessories + Finishes

#### FEATURES

Solid Brass or Black anodised Retreat Wall Hook

Coat Hanger powdercoated in standard colour of your choice

Umbrella Stand powdercoated in standard colour of your choice

Metal Shelves + Planter Shelves powdercoated in standard colour of your choice

Planter shelves have a 160mm diameter hole for housing self contained pots

Upholstery: 1370W+ fabric is run up and over panels. Note this may effect some fabrics with a pattern. Panels can have 2 fabrics one either side - Fabric A + Fabric B. On a curve A is the inside of the curve and B is the outside.

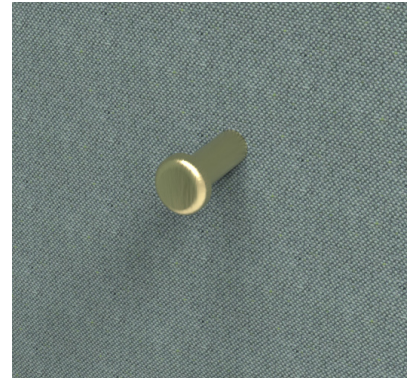
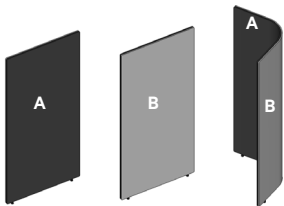

Retreat wall hooks



Coat rail



Umbrella stand

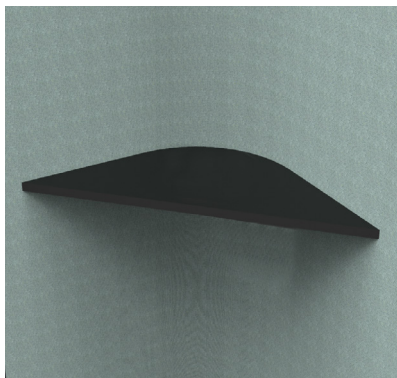

Shelf

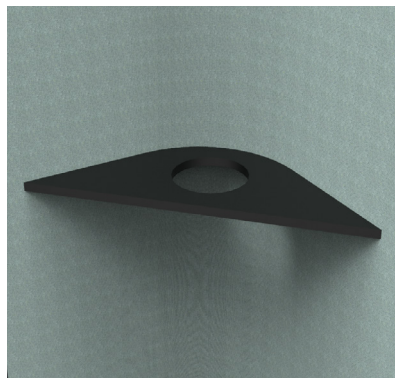

Planter shelf



Planter shelf with plant

# Retreat

## Wall

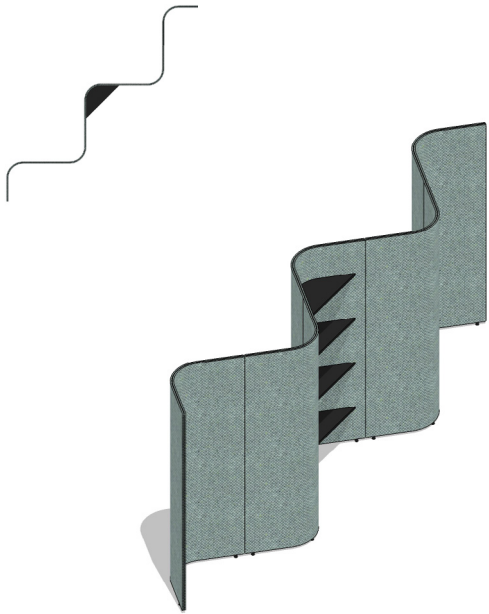

### Retreat Wall - Zigzag

4x RW-18-C600  
1x RW-18-C600-SH

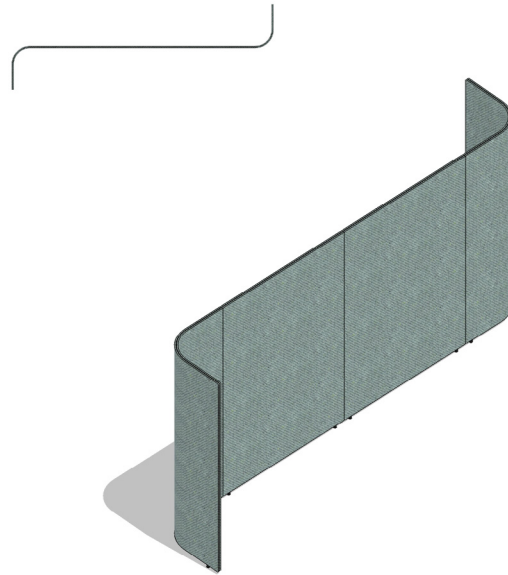

### Retreat Wall

2x RW-18-C600  
2x RW-18-S1200



### Retreat Wall - Planters + Coat Rail Bay

2x RW-18-C600-PSH  
1x RW-18-U1200-CR-UM-HBR

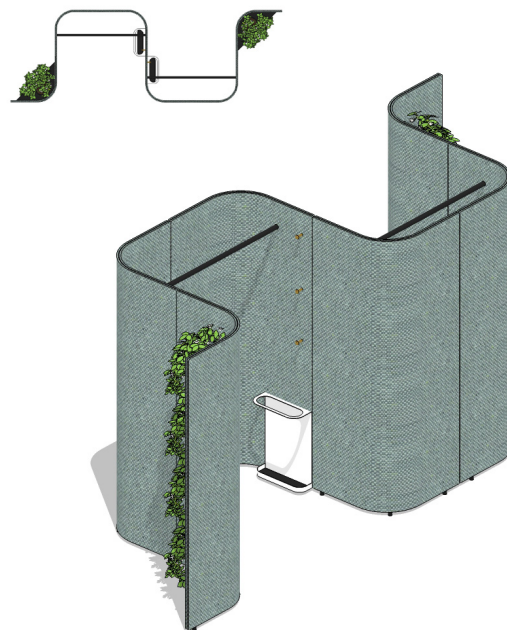

### Retreat Wall - Deluxe Planters + Coat Rail Bay

2x RW-18-C600-PSH  
2x RW-18-U1200-CR-UM-HBR



# Retreat

## Wall

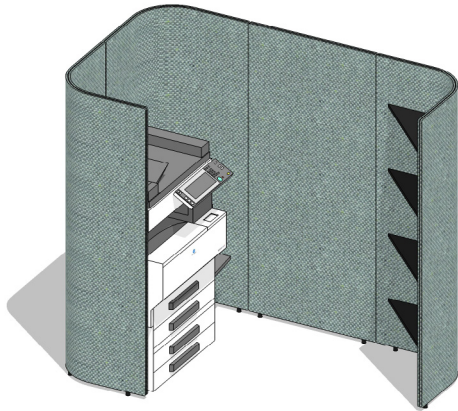
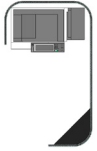

### Retreat Wall - Deluxe Printer Bay

- 1x RW-18-U1200
- 1x RW-18-S800
- 1x RW-18-C600-SH

### Retreat Wall - Nook

- 1x RW-18-C600-PSH
- 1x RW-18-C600
- 1x RW-18-S1000
- 1x RW-18-S600
- 1x RW-18-S600-E

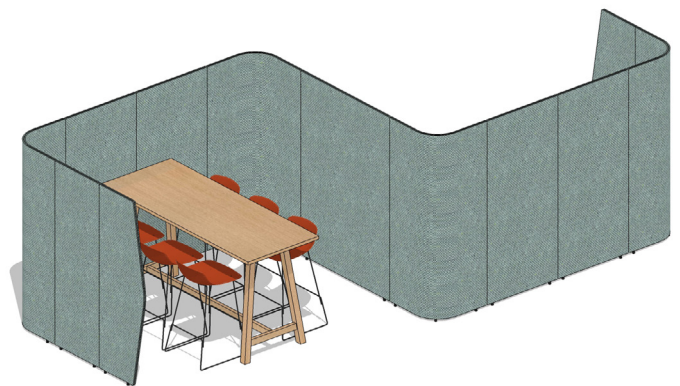
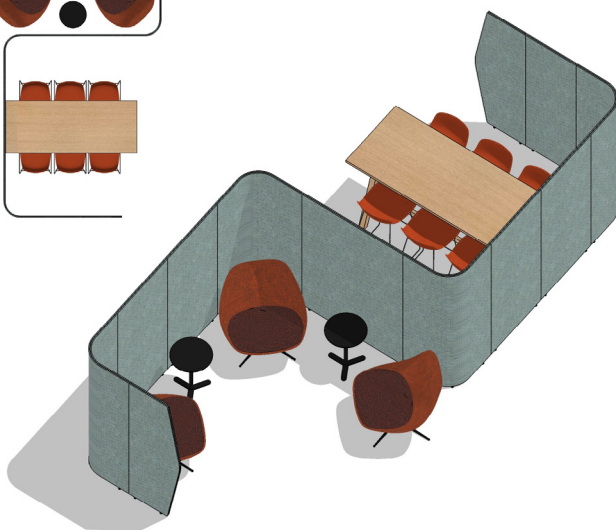
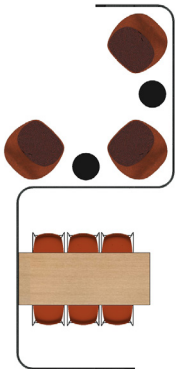

### Retreat Wall - Breakout Bays

- 4x RW-18-C600
- 4x RW-18-S800
- 1x RW-18-S1200
- 1x RW-18-S600
- 2x RW-18-S600-E

# Retreat

## Wall

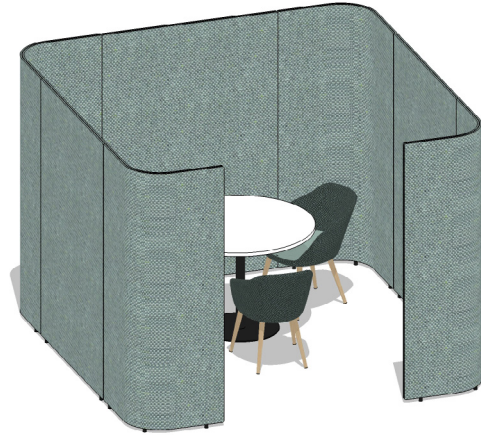
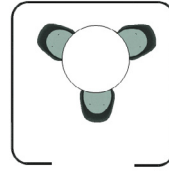

### Retreat Wall - Small Room - 3 person

4x RW-18-C600  
3x RW-18-S1200

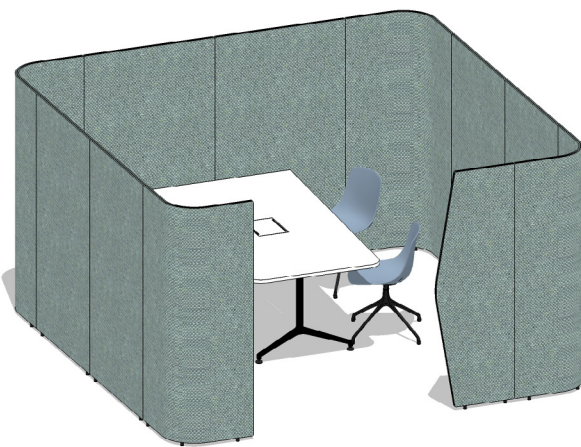
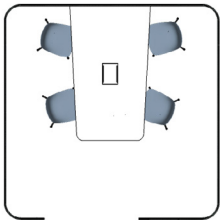

### Retreat Wall - Medium Room - 4 person

4x RW-18-C600  
6x RW-18-S1000  
1x RW-18-S600-E

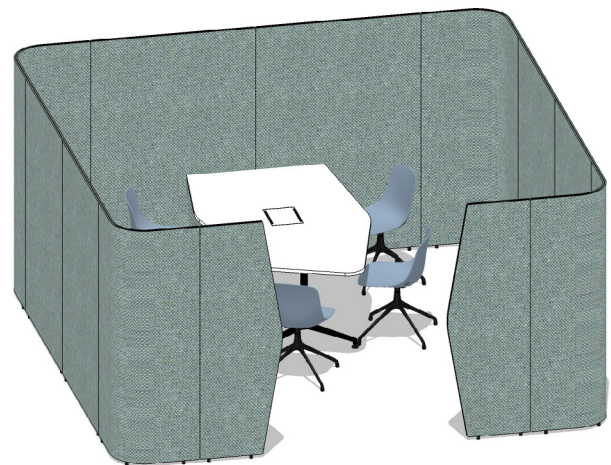
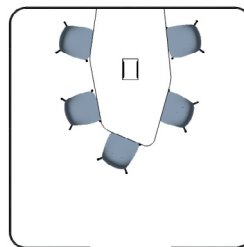

### Retreat Wall Large Room - 5-6 person

4x RW-18-C600  
6x RW-18-S1200  
2x RW-18-S600-E









ecf



1F Marine Parade  
Abbotsford, Victoria  
3067 Australia

T +61 (3) 9818 5444  
F +61 (3) 9818 6655  
info@ecf.com.au



ecf.com.au



ecf.hfa



@ecf\_hfa

