

ecf

RETREAT BOOTH





# Retreat

## Booth

### FEATURES

Freestanding acoustic booths with ergonomically-designed seating, power + AV integration and modular, reconfigurable screens.

#### Dimensions

Back height: 1350H

Seat height: 450H

2, 4 + 6 Seater Booths

Variety of table options including Shift Split for superior ergonomic support and ease of entry into booth

Table tops available in LPL, HPL, veneer or solid timber in the colour of your choice.

Upholstered in fabric 1370W+

Multiple upholstery configurations

Table leg powdercoated in Black or White or any standard powdercoat colour

4 + 6 person booths can have a 43" screen mounted to the screen wall

Optional power integration including Echo Duo, Connect Me 2 + Connect Us

Adjustable levelling glides

10 year warranty

6-8 week leadtime



**Retreat Booth - 2 Person - Open Meeting - With Shift Split and dual monitors**



**Retreat Booth - 4 Person - Enclosed Meeting - With Shift Split table and Arm rests**



**Retreat Booth - 4/6 Person - Open Meeting - With TV**

# Retreat

## Booth

### 2 Person Booths

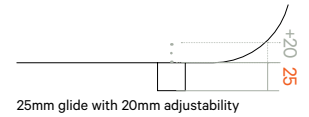

Glide detail

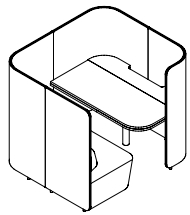

RB-SH-HB2-SS-R

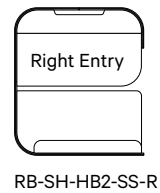
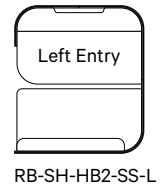
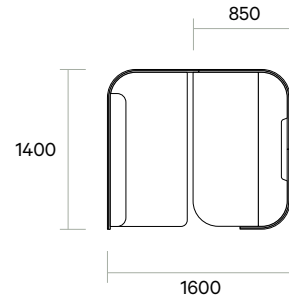
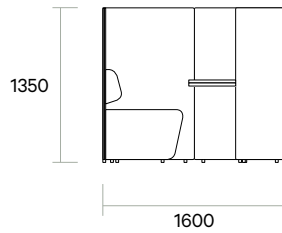

### Retreat Booth - 2 Person - Open Meeting - Shift Split Table - Right Handed Entry

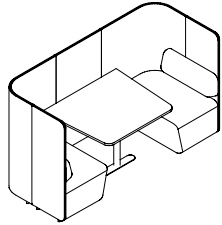

RB-2HB1-SS

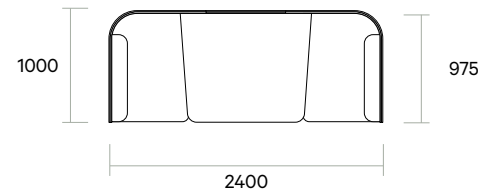
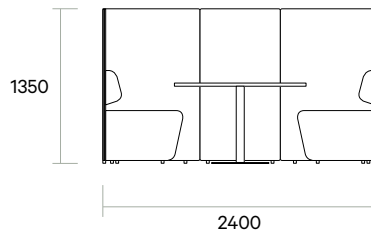

### Retreat Booth - 2 Person - Open Meeting

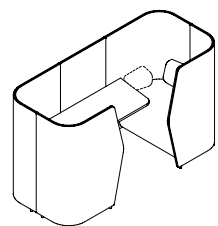

RB-2HB1-EE / RB-2HB1-EE-AR

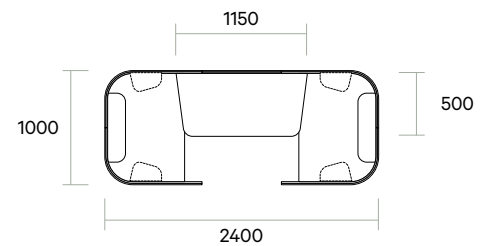
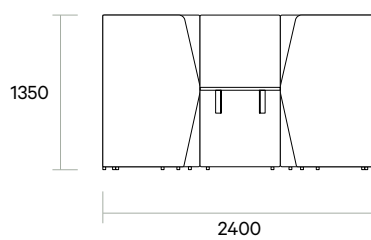

### Retreat Booth - 2 Person - Enclosed Meeting - With or Without Armrests

# Retreat

## Booth

### 4 Person Booths

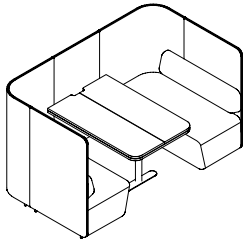

RB-SH-2HB2-SS

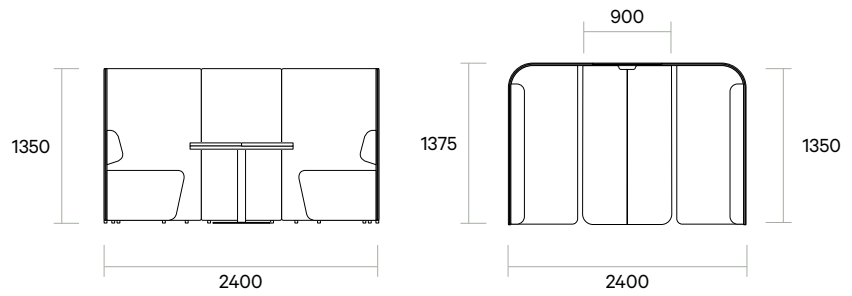

#### Retreat Booth - 4 Person - Open Meeting - Shift Split Table

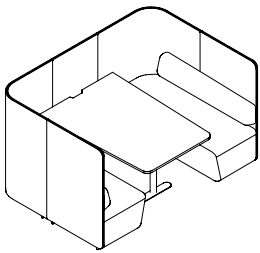

RB-2HB2-SS

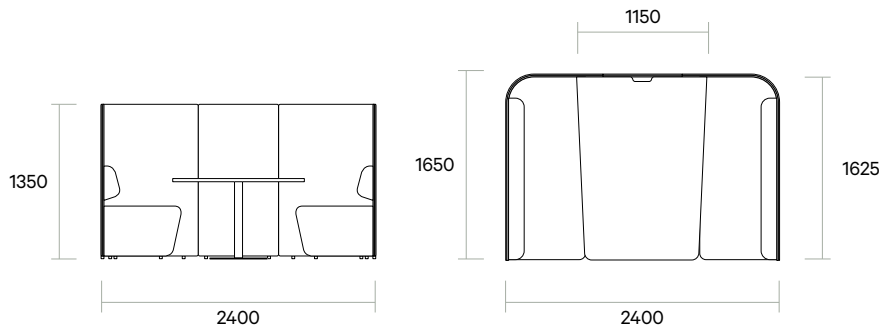

#### Retreat Booth - 4 Person - Open Meeting

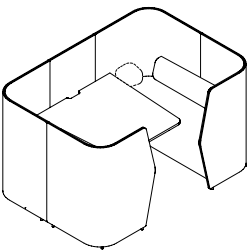

RB-2HB2-EE / RB-2HB2-EE-AR

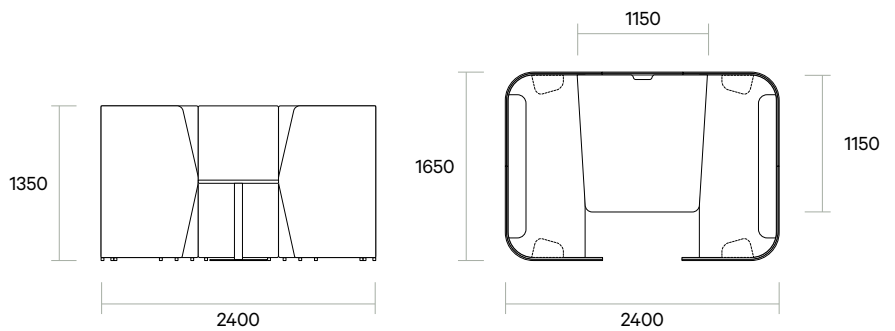

#### Retreat Booth - 4 Person - Enclosed Meeting - With or Without Armrests

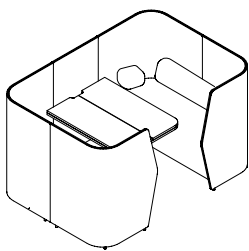

RB-SH-2HB2-EE / RB-SH-2HB2-EE-AR

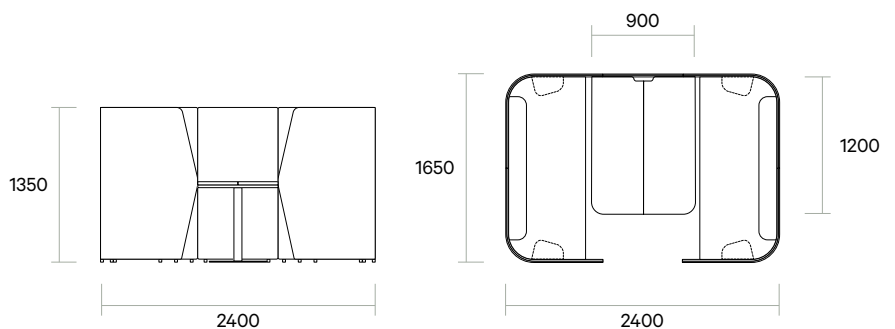

#### Retreat Booth - 4 Person - Enclosed Meeting - With or Without Armrests - Shift Split Table

# Retreat

## Booth

### 6 Person Booths

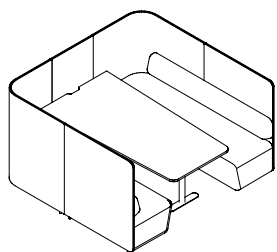

RB-2HB3-SS

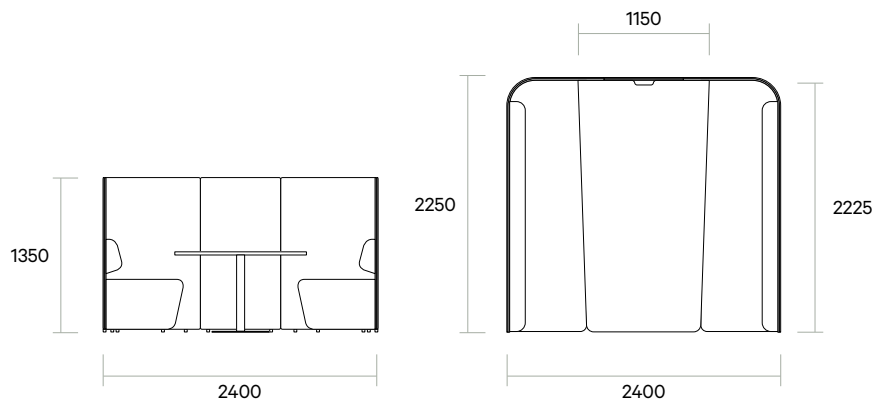

### Retreat Booth - 6 Person - Open Meeting

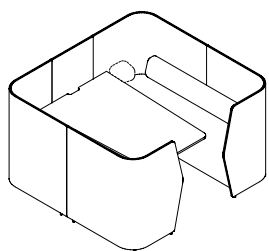

RB-2HB3-EE / RB-2HB3-EE-AR

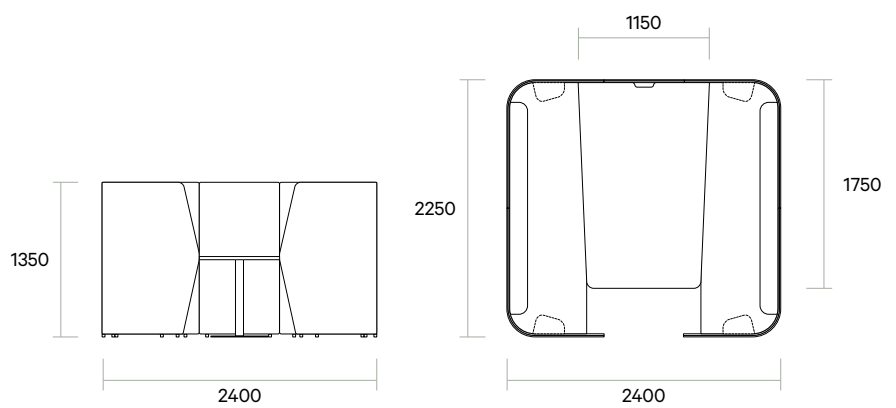

### Retreat Booth - 6 Person - Enclosed Meeting - With or Without Armrests



# Retreat

## Booth

### Power options



Echo Duo - Power / USB A+C



Echo Duo - Power / Wireless

Available with 1x Echo power outlet and with a mix of either:  
1x Echo USB A+C / 1x Wireless charging /  
1x grommet for pulling through cables

#### P1 - Echo Duo



Connect Me 2 - closed lid



Connect Me 2 - opened lid

2x Power outlet, 2x Data provision and AV/USB tiles if required

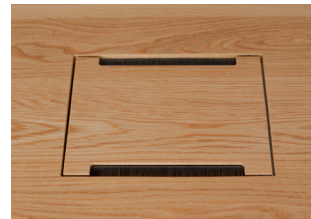

Connect US - closed lid



Connect US - opened lid

4x Power outlets, 2x Twin data holes and  
space for AV/USB tiles if required or fast charge USB A+C

#### P2 - Connect Me 2



VGA socket



HDMI



3.5 or 6.5 stereo  
jack



Mini XLR 3 or 4  
microphone jack

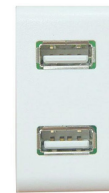

USB pass through or  
USB Fastcharge



RCA socket

#### AV/data for Connect Me / Connect US modules



# Retreat

## Booth

### Cable Management options

#### FEATURES

##### Cable cutout on table top - scallop

Allows underdesk cables to reach desktop.

Included in all versions of the below Booths:

RB-2HB2-SS

RB-2HB3-SS

RB-2HB2-EE

RB-2HB3-EE

##### Underdesk tray

Keeps monitor and power cords secured and static below desktop. This means less risk of damage to the cords because they don't move when the desktop is adjusted. This offers a tidier solution with most cables secured under the desktop.

Included in the below Booths:

RB-SH-HB2-SS

RB-SH-HB2-SS-P1

##### Underdesk Cable Sling

Provides streamlined cable management for cables underneath the desktop. Power outlets are also mounted to the underside of the desktop.

Included in the below Booths:

RB-2HB3-EE-P3

RB-2HB3-EE-AR-P3

Optional extra for all other booths

##### Cable Sleeves

Neoprene cable sleeves can be added to carry power and data cables between the floor and tabletop.

Optional extra for all booths

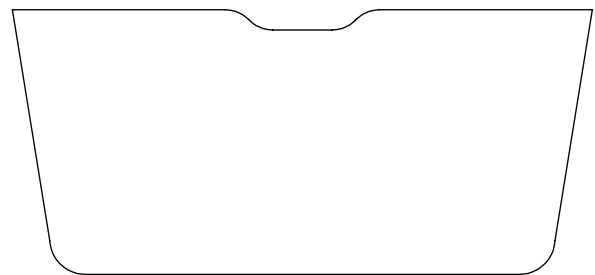

#### Cable cutout on tabletop - scallop

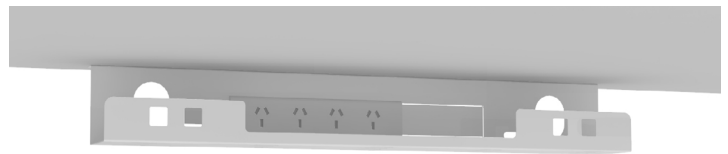

#### Underdesk tray

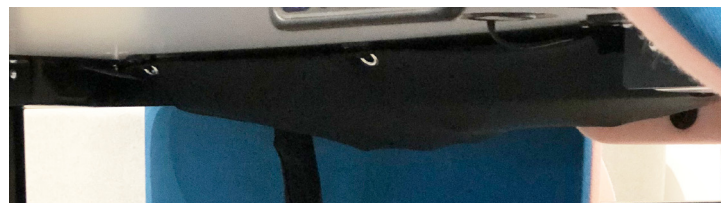

#### Underdesk Cable Sling



#### Cable Sleeve



# Retreat

## Booth

### Finish options



Screen outside    Screen inside    Seat



Lumbar    Armrests

### Fabric upholstery configurations - 1370W+

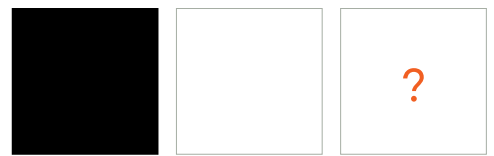

Satin Black    Satin White    Other standard colour

### Powdercoated Table Leg

### 25mm Table Top

- Low pressure laminate
- High pressure laminate
- Veneer
- Solid Timber
- Plywood

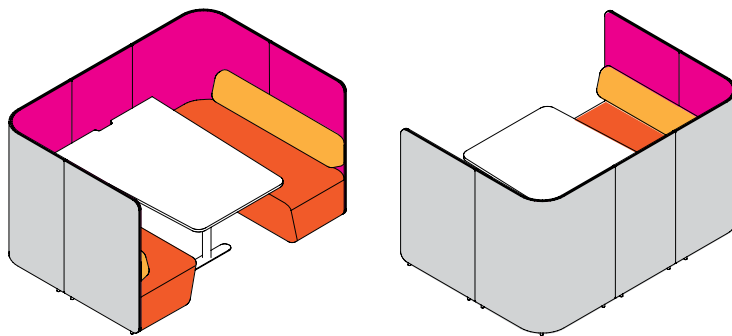

Retreat Booth - 2/4/6 people - Open Meeting

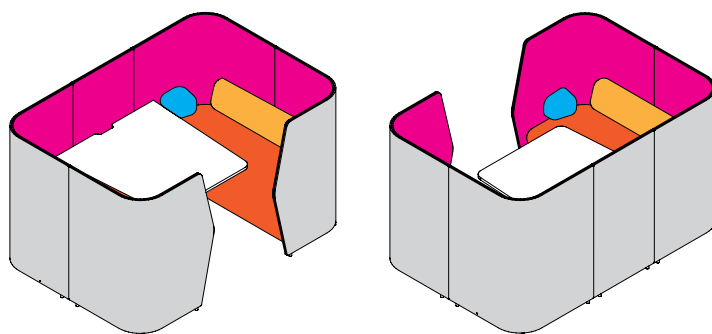

Retreat Booth - 2/4/6 people - Enclosed Meeting



ecf



1F Marine Parade  
Abbotsford, Victoria  
3067 Australia

T +61 (3) 9818 5444  
F +61 (3) 9818 6655  
info@ecf.com.au



ecf.com.au



ecf.hfa



@ecf\_hfa

